

Installation and Maintenance Instruction Manual



Bourdon tube pressure gauge, model 5008

for explosion risk areas pursuant to Directive 2014/34/EU (ATEX)

In the following configuration:

- ###5008###ATEX bourdon tube pressure gauge



Table of contents:

1	General remarks.....	3
1.1	Purpose of this Manual.....	3
1.2	Symbols.....	3
1.3	Limits of liability.....	3
1.4	Copyright.....	3
1.5	Warranty.....	3
1.6	Manufacturer’s address, customer services.....	3
2	Safety.....	4
2.1	General sources of hazards.....	4
2.2	Use in accordance with intended purpose.....	4
2.3	Operator’s responsibility.....	4
2.4	Staff qualifications (target group assessment).....	4
2.5	Signs/Safety markings.....	4
2.6	Safety equipment.....	5
2.7	Environmental protection.....	5
3	Use in explosion risk areas pursuant to Directive 2014/34/EU (ATEX).....	5
3.1	Bourdon tube pressure gauge model 5008.....	5
4	Technical data.....	5
5	Labeling on the device.....	6
5.1	Labeling on the device for explosion risk areas (ATEX).....	6
6	Construction and function.....	6
6.1	Overview.....	6
6.2	Description of function.....	6
6.3	Description of components.....	6
6.4	Accessories.....	7
7	Transport.....	7
7.1	Safety.....	7
7.2	Transport inspection.....	7
7.3	Storage.....	7
8	Assembly/Installation.....	7
8.1	Safety.....	7
8.2	Preparations (requirements for the installation location).....	7
8.3	Mounting/Installation.....	7
8.4	Starting up.....	8
8.5	Subsequent relocation of the gauge (by the customer).....	8
9	Servicing.....	8
9.1	Safety.....	8
9.2	Check on function, and recalibration.....	8
9.3	Cleaning and maintenance.....	8
10	Faults.....	9
10.1	Safety.....	9
10.2	Conduct in the event of faults.....	9
10.3	Fault table.....	9

10.4	Conduct following fault rectification	9
11	Removal, disposal.....	9
11.1	Safety.....	9
11.2	Removal.....	9
11.3	Disposal.....	9
12	Appendix	9
12.1	Data sheet for Bourdon tube pressure gauge 5008	9
12.2	Declaration of Conformity	10

1 General remarks

1.1 Purpose of this Manual

This Operating Manual contains fundamental and essential advice to be followed for the installation, operation and servicing of the device. It must be read without fail before assembly and start-up of the device by the fitter, the operator and the specialist personnel responsible for the device. This Operating Manual must be available at the point of use at all times.

The following sections about general safety information (2) and also the following specific advice regarding the intended purposes (2.2) and through to disposal (11.3) contain important safety information which, if not followed, may result in risks for people and animals, or to property and buildings.

1.2 Symbols



Warning!

This indicates a possibly hazardous situation where failing to follow advice may result in risks to people, animals, the environment and buildings.



Information!

This emphasizes key information for efficient, fault-free operation.

1.3 Limits of liability

Failure to respect this safety information, the envisaged uses or the limit values relating to use indicated in the technical data for the device may result in risk or to injury to people, the environment or the plant.

Claims for compensation for damage against the device supplier are excluded in such an eventuality.

1.4 Copyright

This Operating Manual may only be copied and passed on as a complete document without the special permission of the publisher.

1.5 Warranty

For the product described here, we offer a warranty pursuant to Section 6 Guarantee in Respect of Defects in our General Terms and Conditions of Delivery and Payment.

1.6 Manufacturer's address, customer services

Ashcroft Instruments GmbH
Max-Planck-Strasse 1
D-52499 Baesweiler. Germany

Tel.: +49 (0) 2401/808-888
Fax.: +49 (0) 2401/808-999
E-mail: customer.service@ashcroft.com
Web: www.ashcroft.eu

2 Safety

2.1 General sources of hazards

Pressure gauges are pressurized parts where failure can result in hazardous situations. The selection of pressure gauge should be made in accordance with the rules set out in EN 837-2.

2.2 Use in accordance with intended purpose

The devices are only to be used for the intended purpose as described by the manufacturer.

The devices are used for direct display of overpressures, vacuum and compound pressure.

For each use scenario, the corresponding set-up regulations must be respected. If used in explosion risk areas, the following conditions are to be respected for the individual finishes.

The integrated switching elements are inductive proximity switches with a groove design, supplied by isolating switch amplifiers with certified intrinsically safe power circuits. If the set limit values are exceeded, the output circuits are opened or closed.

2.3 Operator's responsibility

Safety instructions for proper operation of the device must be respected. They are to be provided by the operator for use by the respective personnel for installation, servicing, inspection and operation. Risks from electrical energy and from the released energy of the medium, from escaping media and from improper connection of the device must be eliminated. The details for this are to be found in the corresponding applicable set of regulations, such as DIN EN, UVV (accident prevention regulations) and in sector-specific instances of use (DVWG, Ex- GL, etc.) the VDE guidelines and the regulations supplied by local utilities companies.

The device must be taken out of service and secured against inadvertently being restarted, if the presumption is that risk-free operation is no longer possible (see Chapter 10: Faults).



Conversion works or other technical alterations to the device by the customer will violate the approval for hazardous area and are not permitted. This also applies to installation of spare parts. Possible conversions or alterations may only be carried out by the manufacturer.

The operational safety of the device is only guaranteed where it is used for its intended purpose. The specification of the device must be adapted to the medium used in the plant. The limit values indicated in the technical data must not be exceeded.

The safety information detailed in this Operating Manual, existing national regulations for accident prevention, and the operator's internal regulations regarding working, operations and safety must be respected.

The operator is responsible for all specified servicing, inspection and installation works being carried out by authorized and qualified specialists.

2.4 Staff qualifications (target group assessment)

The device may only be installed and started up by specialist staff who are familiar with installation, start-up and operation of the product.

Specialist staff are people who are able to assess the work assigned to them on the basis of their specialist training, their knowledge and experience and their knowledge of the relevant standards, and can identify possible risks.

For devices in explosion-protected configuration, these staff must have been trained or instructed in, or be authorized for, working on explosion-protected devices in potentially explosive plants.

2.5 Signs/Safety markings

The pressure gauge and its surrounding packaging carry markings. These markings show the article number, measurement range and manufacturer. The pressure gauge can be provided with additional signs and safety markings advising on special conditions:

- Advice on the filling liquid
- Advice on calibration
- Safety marking pursuant to EN 837-1
- Ex (for ATEX configuration)
- Oil-can deleted (if oxygen is used)

2.6 Safety equipment

This device is fitted with a rear wall or plug capable of being blown out. For a description, please refer to Chapter 6.3.4.

The window uses multi-layer safety glass.

2.7 Environmental protection

This device may optionally contain a filling liquid (e.g. glycerin or silicone oil). The provisions set out in the REACH regulation on production and use of chemicals are to be respected, and the relevant safety data sheets from the manufacturers of the chemicals are available on our website for download.

3 Use in explosion risk areas pursuant to Directive 2014/34/EU (ATEX)

3.1 Bourdon tube pressure gauge model 5008

Area of use:

Explosion risk areas Zone 1 and 2, and 21 and 22, risk from gases and dry dust

Permitted temperatures:

Permitted ambient temperature -20°C to +60 °C.

Permitted medium temperature in the pressure gauge depends on the working conditions, not on the gauge design.



Warning! With gaseous media, the device temperature may increase due to compression heat. In such cases, the rate of the pressure change must be regulated or the permitted temperature of the measuring medium reduced.

Note:

To avoid additional temperature increase, the devices should not be exposed to direct exposure to sunlight when in operation!

The effects of impact are considered as negligible.

The standards DIN EN ISO 80079-36:2016-12 and DIN EN ISO 80079-37:2016-12 are applicable with regard to explosion protection. The relevant requirements of these standards are satisfied.

The documentation has been filed with TÜV-Nord-Cert (see declaration of conformity).

Labeling:

CE  II 2 GD c IIC Tx

4 Technical data

The detailed technical information can be found in the documents in the Appendix, Chapter 12.

5 Labeling on the device

The label with the serial number and type designation is located on the outside of the housing. The materials identifier is encoded in the type designation.

5.1 Labeling on the device for explosion risk areas (ATEX)

The label (e.g. ATEX temperature class T4) with the marking for explosion risk areas is located on the outside of the housing.

###5008####ATEX

Ashcroft
 Instruments GmbH
 Type : 5008
 Range : 0-15000 psi

Tamb : -20...60°C
 File No.: 35118307

CE  II 2 GD c IIC Tx

6 Construction and function

6.1 Overview

- 1 Bourdon tube
- 2 Socket and process connection
- 3 Movement
- 4 Pointer
- 5 Dial
- 6 Window
- 7 Crimped ring
- 8 Gasket
- 9 Vent valve
- 10 Case

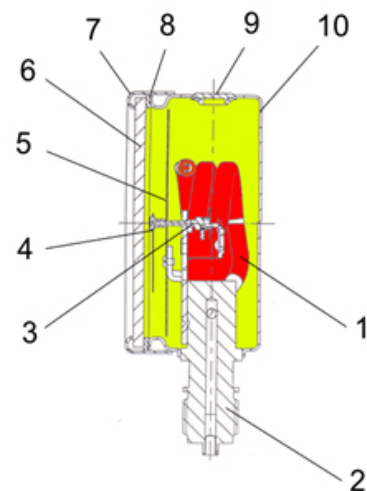

6.2 Description of function

The sensing element, a bourdon tube (C-form or helical) that is welded to the socket, will be exposed from inside with pressure. Under pressure the elastic tube is deflecting against the zero position. This deflection is proportional to the adjacent pressure. The movement transfers the deflection to the pointer.

The display of the measured value is given on a 270° scale.

6.3 Description of components

6.3.1 Scale with pointer

The pressure gauge is equipped with a dial face and pointer pursuant to EN 837-1, nominal size 63 mm.

6.3.2 Instrument connection

The instrument connection is located on the bottom side or at the back side of the pressure gauge and is a threaded connection.

6.3.3 Vent valve

The vent valve for the housing is located on the top side. If the nipple is pulled out, the housing is ventilated and the pressure which has built up in the housing due to the influence of temperature is discharged. With the valve closed, protection class IP 67 is achieved.

6.4 Accessories

Please contact the manufacturer regarding special tools and accessories.

7 Transport

7.1 Safety

The pressure gauge should be protected against the effects of knocks and impacts. The device should only be transported in the packaging provided, to protect against glass breakage. The device should only be transported in a clean condition (free of residues of measuring media).

7.2 Transport inspection

The delivery must be checked for completeness and damage during transport. In the event of damage during transport, the delivery must not be accepted, or only accepted subject to reservation of the scope of the damage being recorded and, if necessary, a complaint initiated.

7.3 Storage

The pressure gauge must be stored in dry, clean conditions, within a temperature range of -40 to +60 °C, protected against direct exposure to sunlight and protected against impact damage.

8 Assembly/Installation

8.1 Safety

To ensure safe working during installation and servicing, suitable shut-off valves must be installed in the plant (see 6.4 Accessories), enabling the device:

- To be depressurized or taken out of operation;
- To be disconnected from the mains supply for repair or checks within the relevant plant;
- Or to enable function tests of the device to be performed “on site”.

During the works to mount/install the gauge, the plant must be protected against being switched back on.

8.2 Preparations (requirements for the installation location)

- A check on suitability of the device for the medium to be measured, the scope of the measurement range and of the protection against special conditions such as vibrations, pulsations and pressure spikes.
- A bracket must be installed to support the pressure gauge if the metering pipe is not able to provide adequate support.
- The installation location should be chosen such that the work-spaces for operating personnel are not located to the rear of the pressure gauge.

8.3 Mounting/Installation

8.3.1 Process connection

As standard, the device is equipped for pipework mounting with a pressure connection shank pursuant to DIN EN 837-1. The device is calibrated ex works for vertical installation.

- Connection to be undertaken by authorized and qualified specialist staff only.
- Use only with the mechanical process connection provided – regarding the configuration, see order code on the device type label, with a matching threaded seal.
- When connecting the device, the pipes must be depressurized.
- The pressure metering pipe must be laid inclined in such a way that, for example, for measurements of fluids no air pockets can form, and for measurements of gases no water pockets. If the necessary incline is not achieved, then at suitable points water separators or air separators must be installed.
- The pressure metering pipe must be kept as short as possible and laid without sharp bends, to avoid the occurrence of irritating delays.

- With liquid measurement media, the pressurized connection pipe must be degassed, since any gas bubble inclusions result in measurement error.
- If water is used as the measurement medium, the device must be frost-protected.



Safety notice: Only mount using the correct open-jawed wrench, and do not twist the device itself.

8.4 Starting up

The precondition for start-up is proper installation of all electrical feed lines and metering pipes. All connecting lines must be laid such that no mechanical forces can act on the device.

Before start-up, the seal on the pressurized connection line must be checked.

8.4.1 Zero point adjustment

The pressure gauges are supplied calibrated ex works, so that as a rule there is no need for calibration works at the installation point.

8.5 Subsequent relocation of the gauge (by the customer)



Recommendation: Do not remove the pressure gauge from one metering point and fit it in a different place, as there is a risk of the measuring media being mixed, with unforeseeable chemical reactions.

9 Servicing

The device is maintenance-free. However, to ensure reliable operation and a long lifetime for the device, we recommend that it is checked regularly.

9.1 Safety

When undertaking servicing work on the device, the pressure lines must be depressurized and the plant secured against being switched on again.

9.2 Check on function, and recalibration

The check on function and recalibration is carried out at regular intervals, depending on the application. The precise testing cycles should be adjusted in line with the operating conditions and ambient conditions. In the event of various device components interacting, the operating instructions for all other devices should also be taken into account.

- Check on display.
- Check on function, in conjunction with downstream components.
- Check of pressurized connection pipes for seal condition.
- Check of electrical connections.

9.3 Cleaning and maintenance

Cleaning is carried out using a non-aggressive cleaning agent, with the ventilation valve closed and respecting the protection category of the device.

10 Faults

10.1 Safety

Defective or faulty pressure gauges put the operational safety and process safety of the plant at risk, and can lead to a risk or injury to persons, the environment or the plant.

10.2 Conduct in the event of faults

All defective or faulty devices must be taken out of service. If a repair is required, the device must be sent directly to our Repairs Department. We request that all returns of devices are agreed with our Service Department.

10.3 Fault table

Possible situations indicating a fault:

- Jerky or random movement of the pointer
- Pointer does not set to zero for pressure less display
- Bent or loose pointer
- Cracked window
- Leaks when the device is filled
- Damage to housing
- Indications that the measurement system seal is imperfect (discoloration to dial display or of filling liquid)

In these instances, replacement of the pressure gauge is always required.

10.4 Conduct following fault rectification

See Chapter 8.3 Mounting/Installation

11 Removal, disposal

11.1 Safety



Residues of measuring media in and on removed gauges can constitute a risk to people, the environment and equipment. Adequate precautionary measures must be adopted. If necessary, the devices must be cleaned thoroughly (see advice in safety data sheets).

11.2 Removal

- When undertaking servicing work on the device, the pressure lines must be depressurized, the electrical connections isolated from the mains supply, and the plant secured against being switched on again.
- Demount the gauge using a suitable tool

11.3 Disposal



Please help to protect the environment and dispose of or recycle the devices and components used in accordance with the applicable regulations.

12 Appendix







12.1 Data sheet for Bourdon tube pressure gauge 5008

Detailed data sheet is available from supplier's website (see 1.6 Manufacturer's address, customer services)

This table refers to specific documents:

Model	Description	Document
5008	Stainless steel pressure gauge model 5008	DS 635008

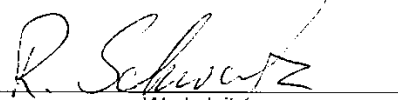
12.2 Declaration of Conformity

	EU-Konformitätsbescheinigung EU-Declaration of Conformity DIN EN ISO IEC 17050-1:2010	
Ashcroft Instruments GmbH Max-Planck-Straße 1 52499 Baesweiler		
erklärt in alleiniger Verantwortung, dass die mit CE gekennzeichneten Produkte <i>declares in sole responsibility that the products marked with CE</i>		
Gerät: <i>Equipment:</i>	Druckmessgerät vom Typ 5008 mit federelastischem Messglied <i>Pressure gauge model 5008 with elastic element</i>	
Kennzeichnung: <i>Marking:</i>	  II 2 GD c IIC Tx Ta = -20°C to +60°C	
Herstellungsdatum: <i>Date of manufacture:</i>	ab 01.05.2017 <i>from 01.05.2017</i>	
die grundlegenden Sicherheits- und Schutzanforderungen erfüllen, in Übereinstimmung mit den unten genannten Richtlinie und Normen. Die Konformitätsaussage bezieht sich auf die Konzeption und Fertigung der oben genannten Produkte. <i>the fundamental safety and protection requirements passed in accordance with the guideline and standards listed below. This declaration of conformity refers to the design and manufacture of the above products.</i>		
Richtlinie <i>Directive</i>	2014/34/EU „Geräte und Schutzsysteme zur bestimmungsgemäßen Verwendung in explosionsgefährdeten Bereichen“ <i>“equipment and protective systems intended for use in potentially explosive atmospheres”</i>	
Angewendete harmonisierte Normen <i>Used harmonized Standards</i>	DIN EN ISO 80079-36:2016-12, DIN EN ISO 80079-37:2016-12	
Benannte Stelle <i>Notification Body</i>	Code number of notified Body: 0044 TÜV NORD CERT Langemarkstrasse 20, 45141 Essen, Germany	
Hinterlegungsnummer: <i>Dossier File No.:</i>	35118307	
Richtlinie <i>Directive</i>	⁽¹⁾ 2014/68/EU „Druckgeräterichtlinie“ <i>„Pressure Equipment Directive“</i>	
Angewendete Prüfnormen: <i>Used test standards:</i>	EN 837-1:1996	
⁽¹⁾ PS >200 bar und V <0,1l, Artikel 4 Drucktragende Ausrüstungsteile, Modul A <i>PS >200 bar and V <0,1l, Article 4 Pressure Accessories, Module A</i>		
Baesweiler, den 11.04.2017 Ort und Datum <i>Place and date</i>	 Werksleiter <i>Operation Manager</i>	
Ashcroft Instruments GmbH	Fon: +49 (0)2401-808-888	Fax: +49 (0)2401-7027
 		
www.ashcroft.eu		