

Table of contents

Safety instructions	E4
General	E5
Selection of assembly process	E6
New EO assembly instructions for 30° final assembly	E8
EO Progressive ring PSR/DPR	E9
EO-2 assembly instructions	E13
Checking instructions for EO assembly tools	E17
EO2-FORM assembly instructions	E18
Checking instructions for EO2-FORM tools	E24
Weld fitting assembly	E25
O-Lok® Plus assembly instructions	E26
Triple-Lok® Plus assembly instructions	E30
Checking instructions for O-Lok® Plus / Triple-Lok® Plus	E34
Flange-Seal assembly instructions	E35



Safety instructions

Tube fittings are safe high-pressure connections

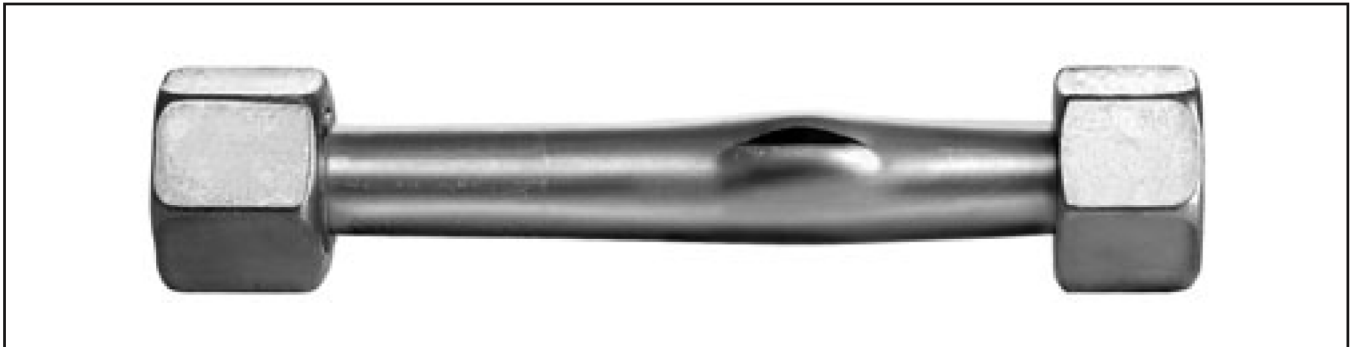

A carefully assembled Parker tube fitting will provide a sealed joint even up to tube burst. Experience has shown that break-downs, re-tightening and leaks can be avoided by following these safety instructions. Please review your fitting procedures.

General safety instructions

- Uncomplete assembly will reduce the pressure and vibration capability of a fitting. It can reduce the life cycle time of a connection and leakage can occur. In extreme cases the connection can fail due to tube shear or tube crack.
- After opening a tube connection, the unit has to be retightened with the same force used during prior assembly. Undertightening can result in leakage and can reduce the vibration resistance. Overtightening can reduce the possibilities of repeated assembly. In extreme cases the components can be destroyed.
- Parker tube fittings are intended solely for connections for fluid applications.
- Observe tube recommendations. Non-standard materials or tolerances lead to incorrect assembly.
- Do not use ball bearings, fitting pins or tapered pins, coins or washers instead of the correct Parker blanking plug as blanking parts for 24° cones.
- Tube connection and fitting body once assembled, should remain together. Fitting body is to be used once only for pre-assembly.
- Air bleeding of tube fittings which are under pressure can be dangerous.
- Tube under tension can lead to vibration failure. Tube length and bend angles are to be adhered to precisely. Fix tube lines with tube clamps.
- Tubes are not to be clamped to one another but to suitable fixed points. Plate brackets, cable connections and fixing elements are not suitable. Tubes are not mountings on which to integrate other components e.g. filters, ventilators or shut-off valves.
- Prevent oscillation, pressure surges and inherent strain by using flexible hoses for example.
- Under and overtightening of fittings during assembly reduces the capacity for withstanding pressure and vibration loads and therefore reduces the life of the tube fitting. Leaks from the tube can occur under these circumstances.
- When dismantling/transporting and re-assembling, make sure that no dirt enters the system, that the connection elements (threads, sealing surfaces) are not damaged, seals are not lost and tubes are not bent or flattened. We recommend the use of suitable protective caps.
- Disassembled fittings are to be checked for accuracy and damage and replaced if necessary.
- Do not use hand cutters or tube cutters.

- Dirt and metal contamination can lead to damage to the system and leaks.
- The operating parameters given (e.g. pressure, temperature, medium compatibility) are to be adhered to.
- Avoid flow rates > 8 m/s. The resulting forces are high and can destroy the tube lines.
- Relevant guidelines (e.g. CE, ISO, BG, TÜV, DIN) are to be observed.
- Weld fittings are manufactured out of weldable materials. No other fittings are suitable for welding.
- EO-Niromont and Parflange 1040LUBSS are high-performance lubricants. The use of other lubricants generally leads to an increase in assembly force.
- The tools and lubricants recommended by Parker guarantee safe assembly.
- Components and tooling of different manufacturers are not necessarily compatible. For complete safety, use only Parker components.
- Fittings are to be handled with care.
- Tubelines need to be adapted tension free of the relevant connectors before assembly. An easy turning of the nut is required for the complete thread length. Otherwise leakage can occur. In extreme cases with additional vibrations tube cracks can occur.
- Vibrations have to be clamped by tube clamps. Independent vibrating units need to be separated with hoses. Otherwise tube cracks can occur.

Specific safety instructions for assembly

- During a progressive ring and EO-2 fitting assembly the tube has to bottom up in the stud or in the tool. Without tube bottoming the ring cannot bite sufficiently. Under load the connection can fail due to tube shear.
- Correctly flared tubes are essential for leak free performance of Triple-Lok® Plus fittings. Special care must be taken over the flare diameter and surface finish.
- Preset bite type fittings (Progressive ring) need a final assembly according to assembly instructions.
- Stainless steel progressive ring fittings have to be preassembled in hardened tools. Otherwise the connection may fail under load due to tube shear.
- Do not assemble progressive rings and functional nuts on self-made standpipe stud ends. There is a risk of false assembly with the result of connection shear under load.
- The use of steel cutting rings for stainless steel tubes or other unauthorised tool combinations leads to incorrect assembly.

In case of doubt please contact your Parker representative!

General

Assembly of Parker tube fittings always follows the same pattern:



Material combinations

- Use recommended tube material
- Select suitable components according to tube material



Tube preparation

- Cut and deburr thoroughly
- Follow recommendations for minimum straight tube length
- Apply support sleeves when necessary

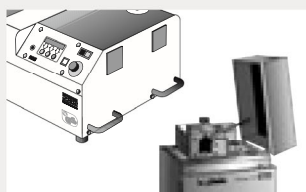

Machine assembly

- Preferred method
- Most efficient method
- Recommended for large EO progressive ring and EO2
- Parflange® recommended for 37° flaring

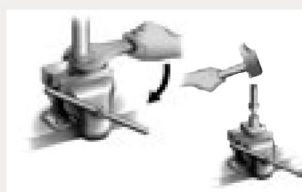

Manual assembly

- Economical for assembly of small quantities
- Suitable for small O.D. tube
- For repair work
- Hand flaring does not provide reliable results
- Stainless steel progressive ring fittings need to be assembled with pre-assembly tools



Assembly check

- Check assembly tube preparation result
- ⚠ Incorrect assemblies must be corrected or scrapped



Final installation

- Final fitting assembly according to instruction
- Do not assemble under tension
- Clamp onto rigid fixtures
- Tighten tube clamps after final fitting installation



Selection of assembly process for bite systems

Manual assembly for field repair			Product	
Procedure	Process Equipment	Process / Time*	EO progressive ring PSR/DPR	EO2
Pre-assembly using EOMAT II machine		 30 sec.	ideal for workshop assembly, not suitable for LL series	ideal for workshop assembly, not suitable for LL series
Pre-assembly using EOMAT III machine		 30 sec.	ideal for serial production	ideal for serial production
Tube forming using EO2-FORM F3 machine		 40 sec.	not applicable	not applicable
Tube flaring using Parflange® 1025 machine		 45 sec.	not applicable	not applicable
Tube flaring using Parflange® 1040 machine		 30 sec.	not applicable	not applicable

Workshop machines for industrial assembly			Product	
Procedure	Process Equipment	Process/Time*	EO progressive ring PSR/DPR	EO2
Direct in fitting		 60 sec.	field repair only, not for efficient production and tubes larger than 22mm OD, preferred method for PSR, not for stainless steel	field repair only, not for efficient production and tubes larger than 22mm OD
Pre-assembly in vice		 45 sec.	field repair only, not for efficient production	field repair only, not for efficient production
Flaring in vice		 120 sec.	not applicable	not applicable
Pre-assembly using HVM-B device		 30 sec.	final assembly in fitting must be 1/2 turn, not for tubes larger than 15mm OD, not for stainless steel	not applicable
Pre-assembly using EO-KARRYMAT		 60 sec.	ideal for repair jobs and small on-site installations, not suitable for volume production	ideal for repair jobs and small on-site installations, not suitable for volume production
Tube flaring using KarryFlare		 60 sec.	not applicable	not applicable

*Average for total assembly time of medium size fitting including assembly check and final tightening

Selection of assembly process for tube forming systems

Manual assembly for field repair					
Procedure	Process		Product		
	Equipment	Process / Time*	EO2-FORM	Triple-Lok® Plus	O-Lok® Plus
Pre-assembly using EOMAT II machine		 30 sec.	not applicable	suitable for workshop assembly, preferred process is Parflange®	not applicable
Pre-assembly using EOMAT III machine		 30 sec.	not applicable	suitable for workshop assembly, preferred process is Parflange®	not applicable
Tube forming using EO2-FORM F3 machine		 40 sec.	ideal for workshop assembly and serial production	not applicable	not applicable
Tube flaring using Parflange® 1025 machine		 45 sec.	not applicable	ideal for workshop assembly, not recommended for mass production, not suitable for assembly of SS tubes over 25mm	ideal for workshop assembly, not recommended for mass production, not suitable for assembly of SS tubes over 25mm
Tube flaring using Parflange® 1040 machine		 30 sec.	not applicable	ideal for workshop assembly and serial production	ideal for workshop assembly and serial production, automatic sleeve feeder available for mass production

Workshop machines for industrial assembly					
Procedure	Process		Product		
	Equipment	Process / Time*	EO2-FORM	Triple-Lok® Plus	O-Lok® Plus
Direct in fitting		 60 sec.	not possible, use EO2 for field repair	not possible, use 1015 device or hand flaring tools for field repair	not possible, use braze sleeves or hose lines for field repair
Pre-assembly in vice		 45 sec.	not possible, use EO2 for field repair	not possible, use 1015 device or hand flaring tools for field repair	not possible, use braze sleeves or hose lines for field repair
Flaring in vice		 120 sec.	not applicable	field repair only, not for efficient production, not for stainless steel tubes	not possible, use braze sleeves or hose lines for field repair
Pre-assembly using HVM-B device		 30 sec.	not applicable	not applicable	not applicable
Pre-assembly using EO-KARRYMAT		 60 sec.	not possible, use EO2 for field repair	not applicable	not applicable
Tube flaring using KarryFlare		 60 sec.	not possible, use EO2 for field repair	ideal for repair jobs and small on-site installations, not suitable for industrial production	not applicable

*Average for total assembly time of medium size fitting including assembly check and final tightening

New EO assembly instructions for 30° final assembly

Traditional pre-assembly

- According to DIN 3859 T2
- Can be used optional as usual
- Machine preset Δ manual preset



- Machine presetting: Machine preset corresponding to 1/4 turn of nut

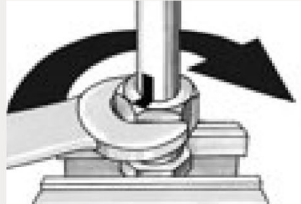

- Manual presetting: Tighten the nut by 1/4 turns

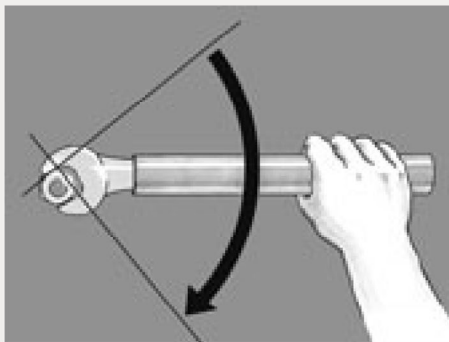

Final assembly
Before 90°
 1/4 turn
 after perceptible rise in force

Optimized EO pre-assembly

- Machine preset Δ manual preset



- Machine presetting: Machine preset corresponding to 1/2 turn of nut

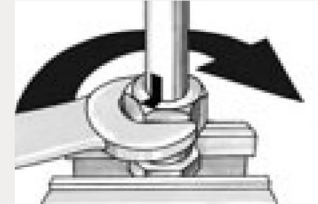

- Manual presetting: Tighten the nut by 1/2 turns

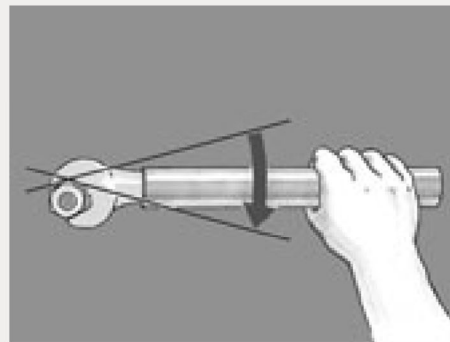

Final assembly
Now 30°
 1/12 turn
 after perceptible rise in force

EO progressive ring PSR/DPR



Material combinations

- Select suitable EO progressive ring fitting

Tube material	EO-Fitting body	assembly instructions
Steel	Steel (LL=D-Ring)	
Stainless Steel	Stainless Steel	Pre-assembly by machine or hardened tool required
Copper	Brass (D-Ring)	
Plastic e.g. Polyamide	Steel, Brass, Stainless Steel	Support sleeve E required Check assembly devices for suitability
Stainless Steel	Steel	Stainless Steel DPR must be used Pre-assembly by machine or hardened tool required



Tube preparation

- Cut and deburr thoroughly
- Do not assemble under tension
- Clamp onto rigid fixtures

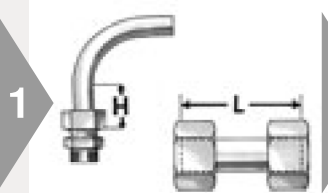

- Minimum lengths of straight tube-ends, $H=2 \times$ nut length
- Use swivel union "GZ" instead of short tubes

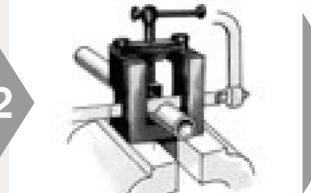

- Cut tube squarely
- max $\pm 1^\circ$ deviation
- ⚠ Do not use pipe cutters
- EO tube-cutting tool (AV) for manual cutting



- Remove internal and external burrs
- max. chamfer 0.3mm x 45°
- Recommendation: In-Ex Tube Deburring Tool 226



Support sleeves VH

- Support sleeve VH for thin wall or soft metal tubes (see chart)



Tube insert E

- Support sleeve E for plastic tubes



- Insert support sleeve like shown



- Drive VH into tube-end

- Support sleeve required
- Support sleeve required for heavily loaded lines (vibrations)

VH selection chart for EO Progressive Ring

For steel tubes material ST 37.4
and for stainless steel tubes material 1.4571 and 1.4541

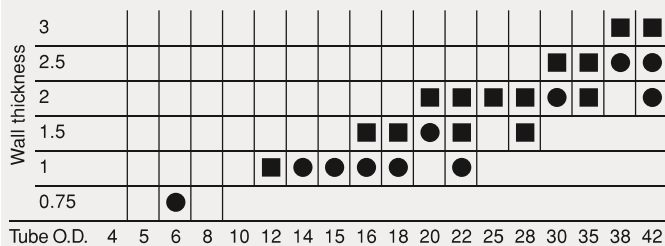

For soft metal tubes (e.g. copper)

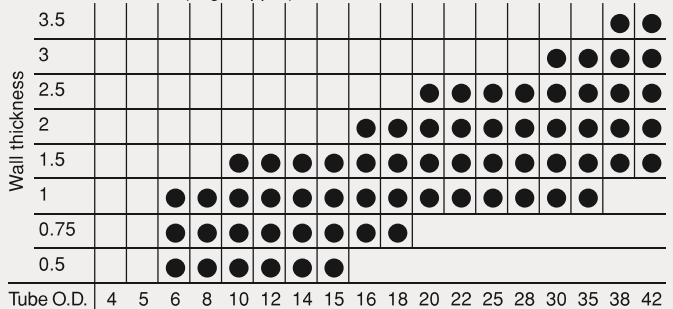

EO progressive ring PSR/DPR



EOMAT II



EOMAT III/A



EO-KARRYMAT

100% Pre-assembly with EOMAT/EO-KARRYMAT

- Preferred method
- Most efficient method
- ⚠ HVMB-device not suitable for 100% assembly of PSR fittings

1

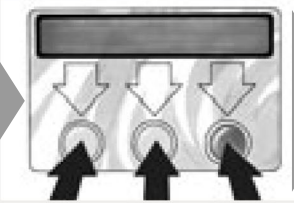

- EOMAT II and EO-KARRYMAT: Adjustment according to pressure chart on machine (PSR/DPR)
Reduction of preset pressures for tube materials softer than steel and stainless steel required
- EOMAT III/A: Menu selection (PSR/DPR)
- Non-EOMAT-machines: Check suitability

2



Ok?

- Control (see checking instructions)
- Clean and lubricate assembly cone and thread regularly

3



- Insert proper tools
- Clean and lubricate assembly cones regularly
- EO-KARRYMAT: Close valve on handpump
- 2-piece backing plates for 35-L and 42-L

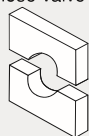

4



- Slide nut and progressive ring as shown onto the end of the tube

5

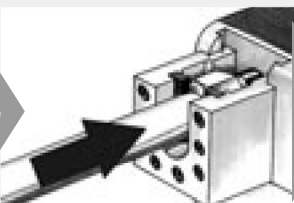

- Place tube with progressive ring and nut into the die
- Press tube-end firmly into the assembly cone



6

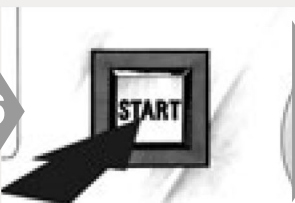

START

- Hold tube firmly
- EOMAT: Press and hold start button
- Use support and foot switch for long tubes
- EO-KARRYMAT: Operate handpump until assembly pressure is reached

7

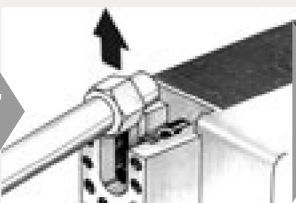

- After completion of pre-assembly, remove the tube for assembly check
- EO-KARRYMAT: Open valve on handpump

8



- ⚠ Check to make sure that a visible collar covers the front of the first cutting edge
- It does not matter if the ring can be rotated on the tube-end

9

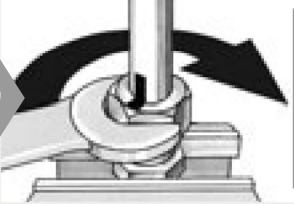

- Assemble fitting until wrench-tight (without spanner extension)
- ⚠ Mark position of nut

10

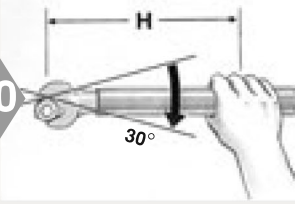

30°

- ⚠ Then tighten fitting firmly by 30° (1/2 flat)
- ⚠ Recommended to use spanner extension for sizes over 20 mm O.D. (see chart)
- Assembly torques are available on request

Spanner length

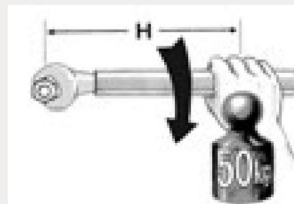

Size	Spanner length H [mm]
22-L	400
28-L 20-S	500
35-L 25-S	800
42-L 30-S	1000
38-S	1200

EO progressive ring PSR/DPR

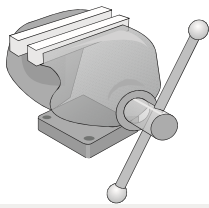

Pre-assembly with hardened tool VOMO

- Reliable method for repair jobs
- Only economic for assembly of small quantities
- ⚠ Stainless steel EO progressive rings must be pre-assembled using a hardened tool (VOMO)
- For tubes over 25mm, EO-KARRYMAT / EOMAT is recommended



1

- ⚠ For stainless steel assembly threads must be lubricated
- Use EO-NIROMONT special high-performance lubricant for stainless steel fittings



2

Ok?

- Control (see checking instructions)
- Cones of pre-assembly bodies must be checked regularly (after 50 pre-assemblies) with cone gauges (KONU)
- Clean and lubricate assembly cone and thread regularly



3

- Use pre-assembly tool VOMO
- Fitting body may be used one time only (not for stainless steel)
- Screw on nut until finger-tight

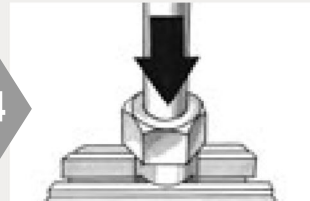

4

- ⚠ Press tube-end firmly into the assembly cone

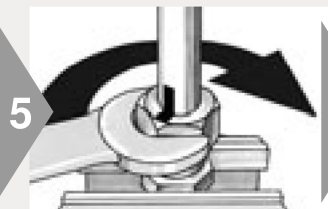
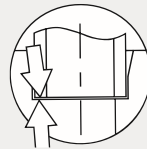

5

- ⚠ Mark position of the nut
- Tighten the nut by 1 1/2 turns
- ⚠ Recommended to use spanner extension for sizes over 20 mm O.D.

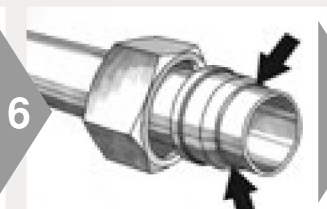

6

- Assembly check:**
- Loosen nut
 - ⚠ Check to make sure that a visible collar covers the front of the first cutting edge
 - ⚠ It does not matter if the ring can be rotated on the tube-end



7

- Assemble fitting until wrench-tight (without spanner extension)
- ⚠ Mark position of nut

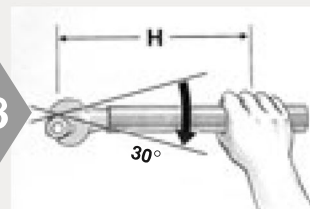

8

- ⚠ Then tighten fitting firmly by 30° (1/2 flat)
- ⚠ Recommended to use spanner extension for sizes over 20 mm O.D. (see chart)
- Assembly torques are available on request

Spanner length

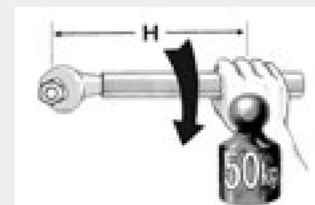

Size	Spanner length H [mm]
22-L	400
28-L 20-S	500
35-L 25-S	800
42-L 30-S	1000
38-S	1200

EO progressive ring PSR/DPR

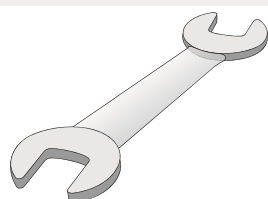

Direct assembly

- Simple procedure for single assemblies of small dimensions
- Not economic for series assembly
- ⚠ Tubes \varnothing 30, 35, 38 and 42 mm must be pre-assembled in vice
- ⚠ Stainless steel connections have to be assembled using pre-assembly tool (VOMO)
- ⚠ Properly cleaned studs ("BE") have to be assembled with pre-assembly tools

1



- ⚠ Lubrication of threads will reduce wear and assembly forces
- ⚠ Threads on stainless steel fittings must be lubricated
- ⚠ Use EO-NIROMONT special high-performance lubricant for stainless steel fittings

2



- Screw on nut until finger-tight
- ⚠ Press tube-end firmly into fitting body

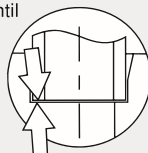

3

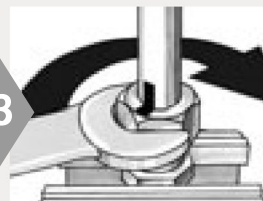

- Mark position of the nut
- Tighten the nut by 1 1/2 turns
- ⚠ Recommended to use spanner extension for sizes over 20 mm O.D. (see chart)
- Fitting body may be used one time only

4



- Assembly check:**
- Loosen nut
 - ⚠ Check to make sure that a visible collar covers the front of the first cutting edge
 - It does not matter if the ring can be rotated on the tube-end

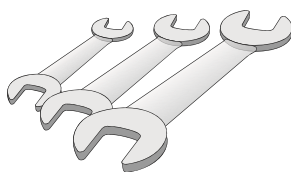

Repeated assembly

- Each time the tube-end has been disconnected, the fitting must be properly tightened again
- ⚠ EO progressive rings cannot be replaced, once assembled

1



- ⚠ Threads on stainless steel fittings must be lubricated
- ⚠ Use EO-NIROMONT special high-performance lubricant for stainless steel fittings

2



- Each time the fitting has been loosened, re-assembly must be performed with the same torque as initial assembly
- The body must be held rigid
- ⚠ Recommended to use spanner extension for sizes over 20 mm O.D. (see chart)

3

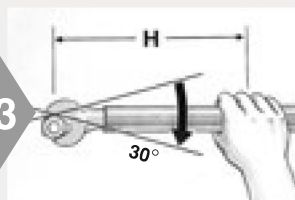

- ⚠ Then tighten fitting firmly by 30° (1/2 flat)
- Assembly torques are available on request
- ⚠ Recommended to use spanner extension for sizes over 20 mm O.D. (see chart)

Spanner length

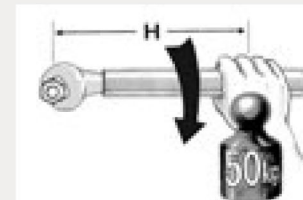

Size	Spanner length H [mm]
22-L	400
28-L 20-S	500
35-L 25-S	800
42-L 30-S	1000
38-S	1200

EO-2 assembly instructions

Detailed assembly-instructions are included in each EO-2 product box. Details on Eomat setting and selection of support sleeves can be found there as well.

Tube preparation

- Cut and deburr thoroughly
- Do not assemble under tension
- Clamp onto rigid fixtures

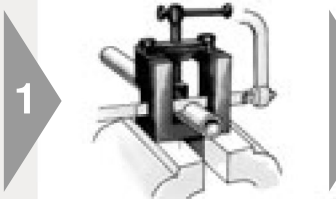

1

- Cut tube squarely
- max $\pm 1^\circ$ deviation
- ⚠ Do not use pipe cutters
- EO tube-cutting tool (AV)



2

- Remove internal and external burrs
- max. chamfer $0.3\text{mm} \times 45^\circ$
- Seal can be damaged by large burrs

Material combinations

- Select suitable FM-type



	Steel tube	Stainless Steel tube	Plastic tube
Steel fitting	FM...A3C	FM...SSA	FM...A3C+E
Stainless Steel fitting	—	FM...71	FM...71+E

Tube insert E

- Tube insert E for plastic tubes



Support sleeves VH

- Support sleeve VH for thin wall or soft metal tubes



1

- Support-sleeve selection: see instruction shipped with product box



2

- Drive VH into tube-end

Use of support sleeves "VH" with EO-2 fittings

Tube O.D.	0.5	0.75	1	1.5	2	2.5	3	3.5	4
4									
6									
8									
10									
12									
14									
15			o						
16									
18									
20									
22									
25									
28									
30									
35									
38									
42					o				

- Functional test required for other materials or dimensions not specified. Support sleeve VH **not required** for EO-2 and steel tube. For stainless steel tube functional test required.
- Support sleeve VH **not required** for EO-2 and steel tube. Support sleeve VH **not required** for EO-2/71 or EO-2/SSA and stainless steel tube.
- o VH **required** for FM/71 and operating pressure above 100 bar.

Replacement of sealing ring/Repeated assembly

- Sealing ring DOZ can be changed separately



1

- After disassembly, sealing ring can be pulled of the tube-end
- Check for damage and replace if necessary
- Abrasion on outer rubber parts does not effect performance

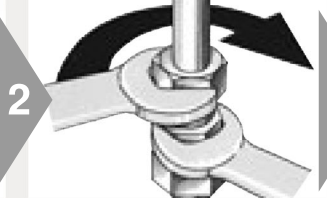

2

- Assemble fitting until wrench-tight (without spanner extension)

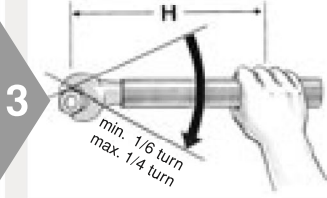

3

- ⚠ Then tighten fitting firmly by min $\frac{1}{6}$ (max $\frac{1}{4}$) turn (1 to $1\frac{1}{2}$ flats)
- ⚠ Recommended to use spanner extension for sizes over 20 mm O.D. (see chart)

Spanner length

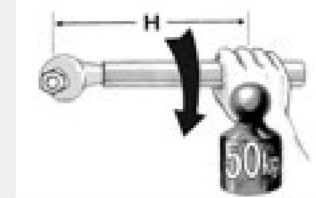

Size	Spanner length H [mm]
22-L	400
28-L	500
35-L	800
42-L	1000
38-S	1200

EO-2 assembly instructions



EOMAT II



EOMAT III/A



EO-KARRYMAT

1

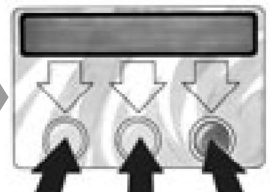

- EOMAT II: Adjustment according to pressure on machine (see instructions shipped with product box)
- EOMAT III/A: Menu selection
- EO-KARRYMAT: Refer to chart on machine
- Non-EOMAT-machines: check suitability

2



Ok?

- Check according to MOK checking instructions
- Use special EO-2 MOK (silver) for Tube-OD 25 mm and larger. Advantages: easy and safe assembly

3



- Insert proper tools
- 2-piece tube backing plates for 35-L and 42-L
- EO-KARRYMAT: Close valve on handpump

Assembly with EOMAT/EO-KARRYMAT

- Preferred method
- Most efficient method
- HVM-B device is not suitable for EO-2

5



- Hold tube firmly
- EOMAT: Press and hold start button
- Use support and foot switch for long tubes
- EO-KARRYMAT: Operate handpump until assembly pressure is reached. Then open valve on handpump

6

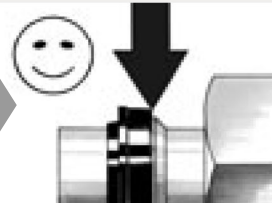

Assembly check:

- Gap between sealing ring and retaining ring must be closed
- A little relaxation (approx. 0,2 mm) is allowed

7

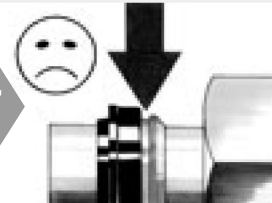

⚠ Gap not closed:

- Check all components, tube, machine, tools and pressure setting
- Repeat assembly with increased pressure if necessary

8



⚠ Threads of stainless steel fittings must be lubricated

- Use EO-NIROMONT special high-performance lubricant for stainless steel fittings

9



- Assemble fitting until wrench-tight (without spanner extension)

10

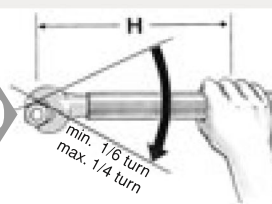

min. 1/6 turn
max. 1/4 turn

- ⚠ Then tighten fitting firmly by min 1/6 (max. 1/4) turn (1 to 1 1/2 flats)
- ⚠ Recommended to use spanner extension for sizes over 20 mm O.D. (see chart)

Spanner length

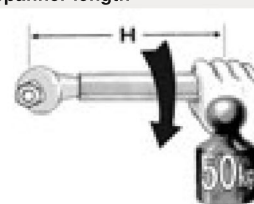

Size	Spanner length H [mm]
22-L	400
28-L 20-S	500
35-L 25-S	800
42-L 30-S	1000
38-S	1200

E14

Catalogue 4100-7/UK

EO-2 assembly instructions

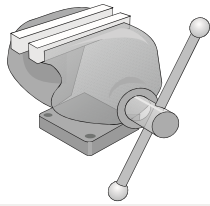

Assembly in vice

- Reliable method
- Only economic for assembly of small quantities



1

- ⚠ Threads on stainless steel fittings must be lubricated
- ⚠ Use EO-NIROMONT special high-performance lubricant for stainless steel fittings



2

- Check according to VOMO checking instructions
- Use pre-assembly tool VOMO
- Fitting body may be used one time only and components must stay together



3

- Push functional nut onto tube-end
- Advantage: Easy tube insertion, particularly large dimensions



4

- ⚠ Press tube-end firmly into the assembly cone
- Screw on nut until finger-tight

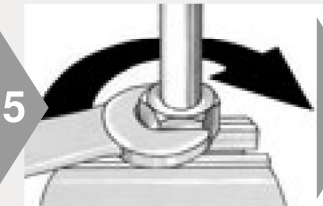

5

- Tighten until sharp increase of resistance (approx. 1 to 1 1/2 turns)
- ⚠ Recommended to use spanner extension for sizes over 20 mm O.D. (see chart)

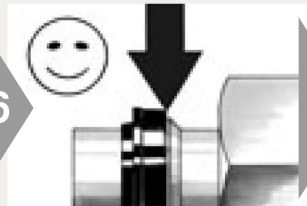

6

- Assembly check:**
- Gap between sealing ring and retaining ring must be closed
 - A little relaxation (approx. 0.2 mm) is allowed



7

- ⚠ **Gap not closed:** Check all components including tube



8

- Assemble fitting until wrench-tight (without spanner extension)

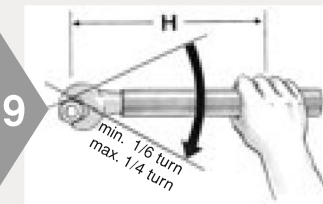

9

- ⚠ Then tighten fitting firmly by min 1/6 (max. 1/4) turn (1 to 1 1/2 flats)
- ⚠ Recommended to use spanner extension for sizes over 20 mm O.D. (see chart)

Spanner length

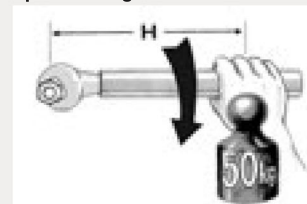

Size	Spanner length H [mm]
22-L	400
28-L 20-S	500
35-L 25-S	800
42-L 30-S	1000
38-S	1200

EO-2 assembly instructions

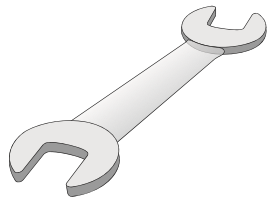

Direct assembly

- Simple procedure for single assemblies of small dimensions
- Not economic for series assemblies
- ⚠ Tubes Ø 30, 35, 38 and 42 mm must be pre-assembled in vice



- ⚠ Threads on stainless steel fittings must be lubricated
- ⚠ EO-NIROMONT is a special high-performance lubricant for stainless steel fittings

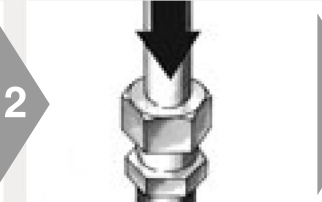

- ⚠ Press tube-end firmly into the assembly cone
- Turn back nut for easy tube insertion

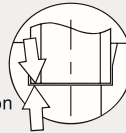

- Tighten until sharp increase of resistance (approx. 1 to 1 1/2 turns)
- ⚠ Recommended to use spanner extension for sizes over 20 mm O.D. (see chart)

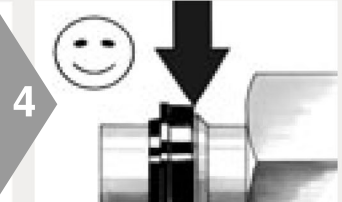

- Assembly check:**
- Gap between sealing ring and retaining ring must be closed
 - A little relaxation (approx. 0.2 mm) is allowed

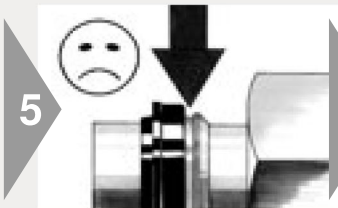

- ⚠ **Gap not closed:** Check all components including tube



- Assemble fitting until wrench-tight (without spanner extension)

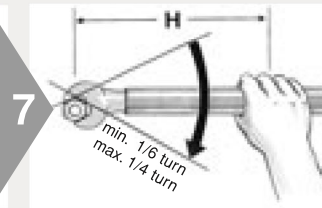

- ⚠ Then tighten fitting firmly by min 1/6 (max 1/4) turn (1 to 1 1/2 flats)
- ⚠ Recommended to use spanner extension for sizes over 20 mm O.D. (see chart)

Spanner length

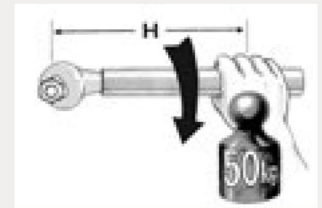

Size	Spanner length H [mm]
22-L	400
28-L 20-S	500
35-L 25-S	800
42-L 30-S	1000
38-S	1200

Checking instructions for EO assembly tools

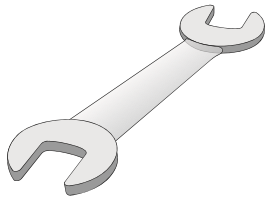

VOMO tools for manual pre-assembly in vice MOK for use in EO assembly machines

- ⚠ Use of damaged, worn or non-suitable tooling may result in fitting failure or machine damage
- ⚠ Tools must be checked regularly, at least after 50 assemblies
- ⚠ Worn tools must be replaced ⚠ Use only genuine Parker tools
- ⚠ Tools must be kept clean and lubricated

1



- Clean cone surface for checking

2

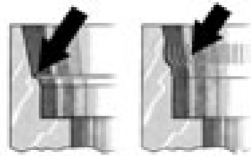

- Visual checks:
Cone must be free of wear, damage or cracks

3



- Check for deformation of geometry
- ⚠ Special cone gauge KONU must be used
- KONU cone gauges are precision measuring devices and must be handled accordingly

4

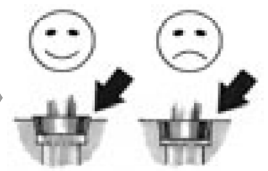

- Check contour:
The rear of the gauge must protrude slightly above the top face of the cone or may be flush

5

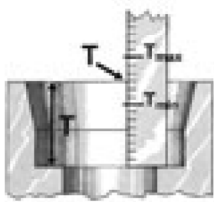

- Check insertion depth
- ⚠ Deviations from the insertion depth can cause leakages

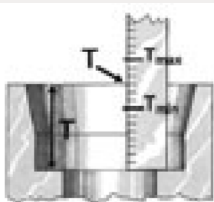

- Insertion depth T

Table: Tool for presetting tool (MOK and VOMO)

Type	T _{min}	T _{max}	Type	T _{min}	T _{max}
6-L	6.95	7.05	6-S	6.95	7.05
8-L	6.95	7.05	8-S	6.95	7.05
10-L	6.95	7.05	10-S	7.45	7.55
12-L	6.95	7.05	12-S	7.45	7.55
15-L	6.95	7.05	14-S	7.95	8.05
18-L	7.45	7.55	16-S	8.45	8.55
22-L	7.45	7.55	20-S	10.45	10.55
28-L	7.45	7.55	25-S	11.95	12.05
35-L	10.45	10.55	30-S	13.45	13.55
42-L	10.95	11.05	38-S	15.95	16.05

EO2-FORM assembly instructions



Material combinations

- Select suitable materials
- See catalogue for exact tube specifications

Material selection chart

Tube material	Fitting and nut material	Sealing material
Steel	Steel	Steel/NBR or Steel/FKM
Stainless Steel	Stainless Steel	Stainless Steel/FKM/NBR
Stainless Steel	Steel	Steel/NBR or Steel/FKM



Tube preparation

- Cut and deburr thoroughly
- Cut and bend tubes exactly

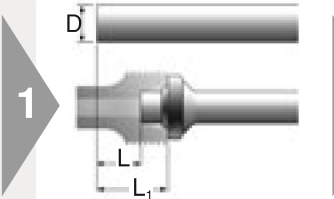

1

- Take extra length into account (see tube preparation chart)

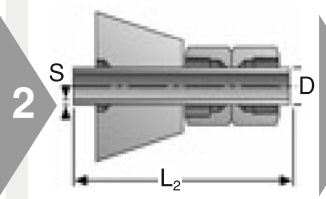

2

- Minimum lengths L_2 of straight tubes (see chart)

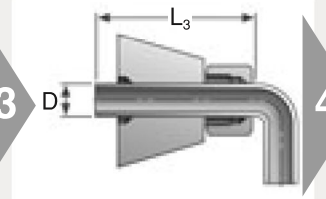

3

- Minimum lengths L_3 of straight tube-ends before bend (see chart)

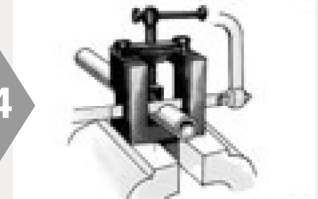

4

- Cut tube squarely
- max $\pm 1^\circ$ deviation
- ⚠ Do not use pipe cutters
- EO tube-cutting tool (AV) for manual cutting



5

- Remove internal and external burrs
- max. chamfer $0.3 \text{ mm} \times 45^\circ$
- Clean tube thoroughly

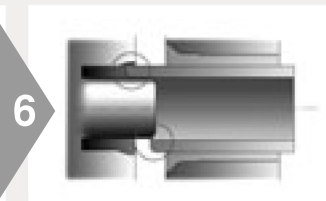

6

- Chips, dirt, internal or external burrs and paint prevent correct tube insertion
- ⚠ Dirty tubes result in worn-out or damaged tools

EO2-FORM assembly instructions

Tube preparation chart - Series L

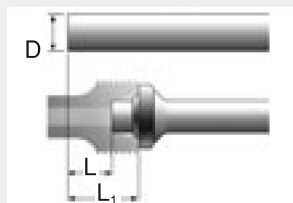

● Extra length

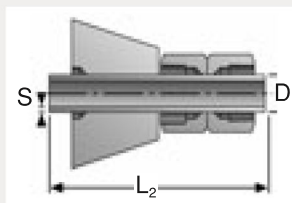

● Minimum tube length

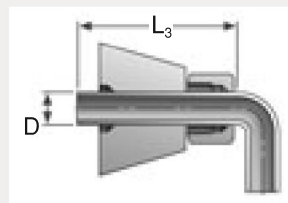

● Minimum straight length before bend

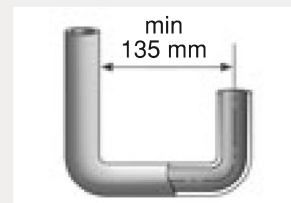

● Minimum clearance of U-shape bends

Tube-OD Series	S Wall thickness	L Steel ± 0.5	L Stainless Steel ± 0.5	L ₁ Steel	L ₁ Stainless Steel	L ₂	L ₃
6L	1	8.5	8.5	15.5	15.5	90	63
	1.5	6	6	13	13		
8L	1	8.5	9	15.5	16	92	65
	1.5	5.5	6	12.5	13		
	2	5		12			
10L	1	5.5	5.5	12.5	12.5	95	68
	1.5	5	6.5	12	13.5		
	2	5	6.5	12	13.5		
12L	1					95	70
	1.5	5	6	12	13		
	2	5	6	12	13		
15L	1.5	5.5	7	12.5	14	102	75
	2	5.5	7	12.5	14		
	2.5	5.5	7	12.5	14		
18L	1.5	5.5	7	13	14.5	110	80
	2	5.5	7	13	14.5		
	2.5	5.5		13			
	3	5.5		13			
22L	1.5	6	8	13.5	15.5	120	90
	2	6	8	13.5	15.5		
	2.5	6.5	8	14	15.5		
	3						
28L	1.5					140	98
	2	6.5	7.5	14	15		
	2.5	6.5	8	14	15.5		
	3						
35L	2	7	8.5	17.5	19	170	115
	3	8.5	10.5	19	21		
	4						
	5						
42L	2	7.5	9	18.5	20	190	125
	3	9	11.5	20	22.5		
	4	9		20			



EO2-FORM assembly instructions

Tube preparation chart - Series S

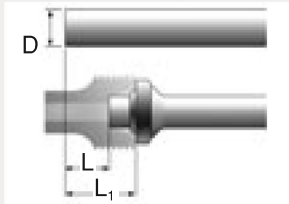

● Extra length

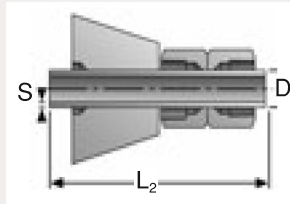

● Minimum tube length

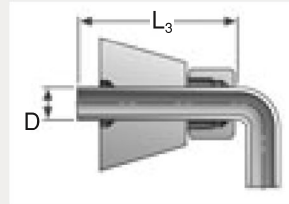

● Minimum straight length before bend



● Minimum clearance of U-shape bends

Tube-OD Series	S Wall thickness	L Steel ± 0.5	L Stainless Steel ± 0.5	L ₁ Steel	L ₁ Stainless Steel	L ₂	L ₃
6S	1	8.5	8.5	15.5	15.5	92	65
	1.5	6	6	13	13		
	2	5.5		12.5			
8S	1	8.5	9	15.5	16	95	68
	1.5	5.5	6	12.5	13		
	2	5		12			
10S	1.5	5	6.5	12.5	14	100	70
	2	5.5	6.5	13	14		
12S	1.5	5	6.5	12.5	14	100	72
	2	5	6.5	12.5	14		
16S	1.5	5.5	7	14	15.5	110	80
	2	5.5	7	14	15.5		
	2.5	5.5	7	14	15.5		
	3	5.5	7	14	15.5		
20S	2	7	8.5	17.5	19	135	98
	2.5	7	8.5	17.5	19		
	3	7	8.5	17.5	19		
	3.5	7		17.5			
25S	2	8.5	10.5	20.5	22.5	155	112
	2.5	8.5	10.5	20.5	22.5		
	3	8.5	10.5	20.5	22.5		
	4	8.5		20.5			
30S	3	8.5	10.5	22	24	165	122
	4	9.5	11	23	24.5		
	5	8.5		22			
38S	2.5		11		27	190	135
	3	11	11	27	27		
	3.5	11		27			
	4	11	12	27	28		
	5	11	13	27	29		
	6	11.5		27.5			
7	11.5		27.5				

EO2-FORM assembly instructions



Tube forming with EO2-FORM F3

- Reliable forming method
- Reliable process



1

- ⚠ Change tool only when drive switched off (button OFF)
- ⚠ Obey safety instructions



2

- Open doors to access tools and handling devices
- Tool handling devices are stored in middle on top

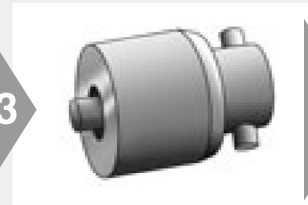

3

- Select suitable forming pin according to tube material, outer diameter and wall thickness



4

- Check forming pin for dirt, wear and damage



5

- Use magnetic holder to insert forming pin
- Turn clockwise to lock bayonet fixture



6

- Tilt magneto holder to remove handle



7

- Select suitable clamping die set according to tube outer diameter
- ⚠ Keep stainless tube clamping dies separate from other tube materials to prevent contact corrosion



8

- Check clamping dies for dirt, wear and damage



9

- Use pistol to handle clamping die set
- Pull and hold handle to grab die set



10

- Insert clamping die set until it bottoms up (twist pistol for easy insertion)
- Release handle to fix die set
- ⚠ Never operate machine while pistol is inserted

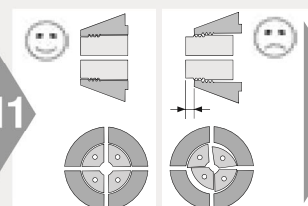

11

- ⚠ Front surfaces must be completely flat
- ⚠ Die segments must fit without gaps

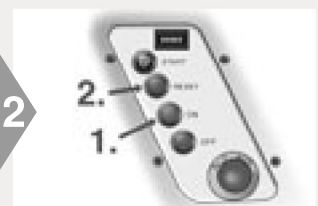

12

- Switch on drive (button ON)
- Each time the drive is switched on, the reset button (RESET) must be pressed first
- The automatic tool recognition is initiated
- ⚠ Clamping dies will close, reset button (RESET) must be held until it lights up
- Lighten of reset button (RESET) indicates "ready to start"



EO2-FORM assembly instructions

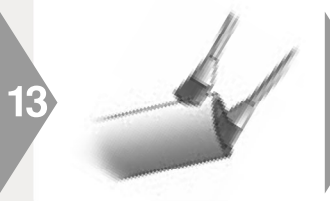

- ⚠ Make sure tube-end is free of burrs, chips and dirt
- ⚠ Lubricate inside and outside of tube-end
- Use EO-NIROMONT for best performance



- Insert tube-end with nut into open tool until it firmly touches the stop at the end
- ⚠ Press tube-end firmly into the tube stop
- Do not turn tube-end anti-clockwise

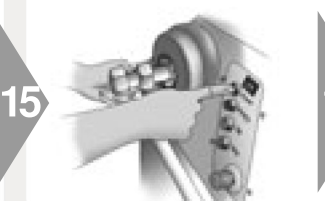

- Press and hold start button (@ START) until tube is clamped
- Instead of start-button (@ START), footswitch can be used
- ⚠ Hold tube firmly until clamping dies are closed
- Use support for long tubes
- ⚠ Do not reach into tool area while machine is working



- Tube can be taken out after the clamping dies are open
- Reset button (RESET) lights up and the machine is ready for the next operation
- Check tools regularly (approx. 50 assemblies) for dirt and wear
- Remove tools for cleaning
- Clean clamping dies with wire brush
- Clean forming die using compressed air
- Replace worn-out tooling

EO2-FORM assembly instructions



Assembly check

- Check assembly result
- ⚠ Incorrect assemblies must be scrapped

Tube OD check

Tube Ø-Series	min Ø [mm]	max Ø [mm]
6-L/S	9	10.2
8-L/S	11	12.2
10-L	13.2	14.2
12-L	15.2	16.2
15-L	18.5	20.2
18-L	21.5	24
22-L	26	27.7
28-L	32	33.7
35-L	39.5	42.5
42-L	46.5	49.5
10-S	13.5	15.5
12-S	15.5	17.5
16-S	19.5	21.5
20-S	24.5	27.5
25-S	30	34
30-S	35	39
38-S	43	47

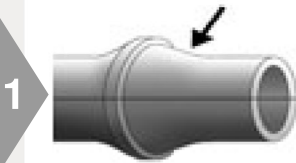

- 1
- Sealing surface (arrow) must be free of scratches and damage

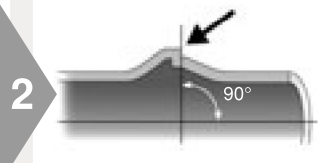

- 2
- Check contour: Contact surface for sealing ring (arrow) must be flat, at right angle to tube



- 3
- Check outer diameter Ø ... (see chart)
 - ⚠ Incorrect tube-ends must be scrapped. Tools must be cleaned and checked

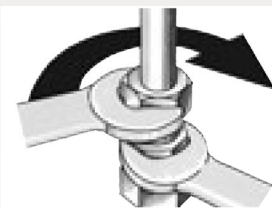

Installation

- ⚠ Tube must fit without tension



- 1
- Place sealing ring (DOZ) onto tube-end



- 2
- Threads of stainless steel fittings must be lubricated
 - EO-NIROMONT is a special high-performance lubricant for stainless steel fittings



- 3
- Tube must fit without tension
 - Assemble fitting until wrench-tight (without spanner extension)

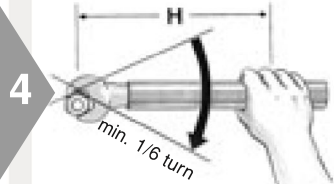

- 4
- ⚠ Then tighten fitting firmly by 1/6 turn (1 flat)
 - ⚠ Recommended to use spanner extension for sizes over 20 mm O.D. (see chart)
 - ⚠ Incorrect assembly reduces performance and reliability of the connection

Spanner length

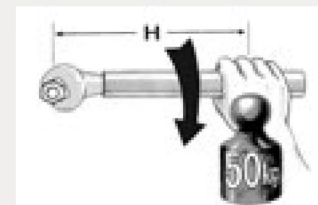

Size	Spanner length H [mm]
22-L	400
28-L 20-S	500
35-L 25-S	800
42-L 30-S	1000
38-S	1200

Checking instructions for EO2-FORM tools



Forming pin and clamping dies for EO2-FORM machine

- ⚠ Use of damaged, worn or non-suitable tooling may result in fitting failure and damage of machine
- ⚠ Tools must be checked regularly, at least after 50 assemblies
- ⚠ Worn tools must be replaced
- ⚠ Use only genuine Parker tools
- ⚠ Tools must always be kept clean and lubricated

1



- Clean forming pin for checking
- Do not disassemble

2



- Visual check:
Surface must be free of wear and damage
- Use air blowgun to remove chips and dirt

3



- Clean clamping pin for checking
- Do not disassemble
- Pins must not be loose or damaged

4

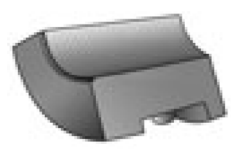

- Visual check:
Grip surface must be clean and free of wear
- Use wire-brush to remove metal particles from grip surface

Weld fitting



Weld fitting assembly

- EO weld nipple and weld fitting
- ⚠ Use weldable material
- ⚠ Depending on application or project specification, special requirements may apply for: Tube preparation, welding process, operator qualification, inspection of welding connection and surface finish



Tube preparation

- Cut and deburr thoroughly
- Do not assemble under tension
- Clamp onto rigid fixtures

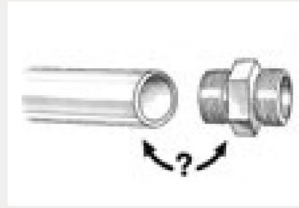

Material combinations

- Select suitable tube material

Fitting material	Tube specification
Steel	Weldable Steel
Stainless Steel	Weldable Stainless Steel

1



- Cut tube squarely
- max $\pm 1^\circ$ deviation
- ⚠ Do not use pipe cutters
- EO tube-cutting tool (AV) for manual cutting

2

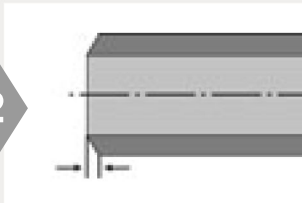

- Bevel tube-end similar to weld nipple bevel

Assembly

3

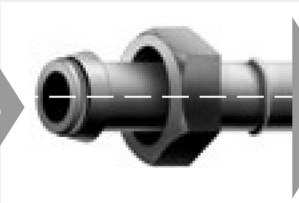

- Slide nut onto tube-end
- Weld fitting onto tube-end
- Fitting and tube must be aligned
- ⚠ Remove all elastomeric seals before welding

4



- Clean weld
- Calibrate inner diameter
- Check welding quality
- Surface protection if necessary

5

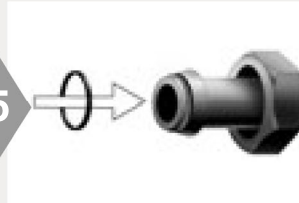

- Assemble O-ring
- Lubricate O-ring for easy assembly
- Avoid damage or twisting of O-ring

6



- ⚠ Threads of stainless steel fittings must be lubricated
- ⚠ Use EO-NIROMONT special high-performance lubricant for stainless steel fittings

7



- Screw on nut by hand until handtight

8

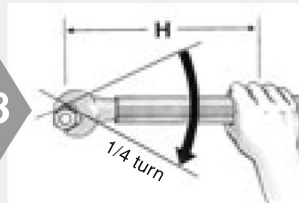

- ⚠ Then tighten fitting firmly by $\frac{1}{4}$ turn ($1\frac{1}{2}$ flats)



O-Lok® Plus assembly instructions



Tube selection

- Select suitable tube material

Steel tube		Stainless Steel tube	
Cold drawn seamless	Welded & redrawn	Cold drawn seamless	
NF A 49330	NF A 49341		
ISO 3304 R	DIN 2393	NF A 49341	
DIN 2391C pt 1	BS 3602/2	DIN 17458 DA/T3	
BS 3602 pt1	SAE J525	ASTM A 269	
SAE J524		1.4571 on request	



Tube preparation

- Cut and deburr thoroughly

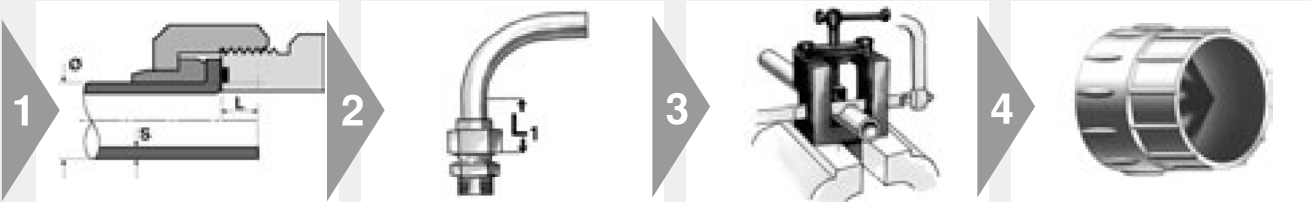

- Calculate tube length before cutting
- Add extra length "L"

- Minimum length of straight tube-ends (see chart below)

- Cut tube squarely
- max. ±1° deviation
- ⚠ Do not use pipe cutters
- Use tube-cutting tool AV for manual cutting

- Remove internal and external burrs
- max. chamfer 0.3 mm × 45°
- Recommendation: In-Ex Tube Deburring Tool 226
- ⚠ Proper deburring and cleaning of inner diameter essential for sealing surface quality

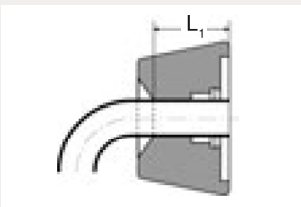

Metric tube [mm]		Minimum straight length to start to bend L1 [mm]	Extra length ~ L [mm] for Tube Wall thickness											
Tube Ø	Wall thickness		1	1.5	2	2.5	3	3.5	4	5				
6	1.0 - 1.5	40	4.5	5.5										
8	1.0 - 2.0	40	5.0	5.0										
10	1.0 - 2.0	40	2.5	4.0	3.5									
12	1.0 - 3.0	50	3.5	4.5	4.5	4.0	4.0							
14	1.5 - 2.0	50			5.0									
15	1.0 - 2.0	50		4.5	5.0									
16	1.5 - 3.0	50		3.0	3.0	3.0	2.5							
18	1.5 - 2.0	50		6.0	5.5									
20	2.0 - 3.5	50			3.5	4.0	4.0	3.5						
22	1.5 - 2.5	50			6.5	7.0								
25	2.0 - 4.0	50				4.0	4.5							
28	1.5 - 3.0	50			6.0	7.0								
30	2.0 - 4.0	50			5.0		5.0			5.0				
32	2.0 - 4.0	50						3.5		3.5				
35	2.0 - 3.0	50					7.0			7.0				
38	2.0 - 5.0	50						5.0		5.0				
50	3.0	50							5.0	4.5				

Inch tube [inch]		Minimum straight length to start to bend L1 [mm]	Extra length ~ L [inch] Tube Wall thickness											
Tube Ø	Wall thickness		0.028"	0.035"	0.049"	0.065"	0.083"	0.095"	0.109"	0.120"	0.134"	0.156"	0.188"	
1/4"	0.020 - 0.065	40	4.5	5.0	4.0									
3/8"	0.020 - 0.095	40		3.5	3.5	4.0	4.0	4.0						
1/2"	0.028 - 0.095	50		3.5	3.5	3.5	3.5	3.5						
5/8"	0.035 - 0.120	50			4.0	4.0	3.0	4.5	4.0	4.5				
3/4"	0.035 - 0.156	50			4.0	4.0	3.0	2.5	3.5	4.0	4.5			
1"	0.035 - 0.188	50					3.5	2.5	4.5	4.5	5.0			
1.1/4"	0.049 - 0.188	50						4.0	3.0	3.0	4.0	4.5	4.5	
1.1/2"	0.049 - 0.220	50					4.5	4.5	5.0	5.0	5.0	5.0	6.0	5.5
2"	0.083 - 0.120	50							4.0	4.0	5.0			

O-Lok® Plus assembly instructions



O-Lok® Plus machine flanging and assembly

- Preferred method
- Most efficient method
- Parflange® recommended

1



- Parflange® machines:
- Select flaring pin according to tube dimensions
 - Use special "SS" pin for stainless steel tube
 - Pin must be clean and free of wear, damage and metal particles
 - Keep flaring pin clean and lubricate regularly

2



- Select flanging dies according to tube dimensions
- Use special "SS" dies for stainless steel tube to avoid contact corrosion
- Grip surface must be clean and free of wear
- Use only genuine Parker tooling for flanging O-Lok® Plus

3



- Load pin into machine
- Ensure lubricating system is filled with oil (1040LUBSS)

4



- Place sleeve in lower die half
- Locate upper die half onto lower half

5



- Place the dies in the die housing

6



- Slide nut onto tube before flanging!
- Open threads towards machine

7

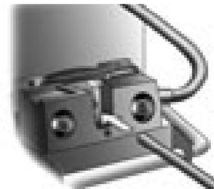

- ⚠ Press tube firmly into the die against the tube stop

8



- Pull down the handle to clamp the tube in the dies (1025)
- 1040 die clamping automatic in cycle
- Press button to start flanging cycle
- ⚠ Keep hands clear off the working area

9



- Parflange® 1025: Unclamp the dies
- Remove tube from machine
- Use die separator to free tube
- Parflange® 1040: Die unclamping is automatic

O-Lok® Plus assembly instructions

Checking of flange

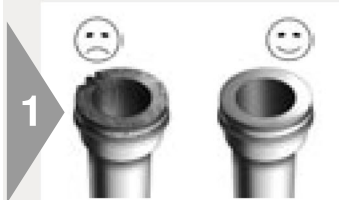

- 1
- Clean flange for inspection
 - ⚠ Check sealing surface for cracks, burrs, scratches and pitting



- 2
- Dimensional check of the flare
 - Flare O.D. should not exceed outside sleeve diameter
 - Flare O.D. should not be less than smaller diameter of front of sleeve
 - When in doubt, measure

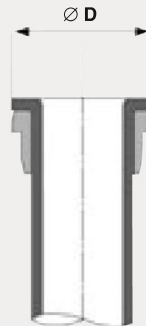

Tube O.D.		Ø D	
mm	In.	min. [mm]	max. [mm]
6	1/4"	12.10	12.75
8		14.85	15.75
10	3/8"	14.85	15.75
12	1/2"	18.00	18.90
14		22.20	23.45
15		22.20	23.45
16	5/8"	22.20	23.45
18		26.60	27.85
20	3/4"	26.60	27.85
22		32.95	34.20
25	1"	32.95	34.20
28		39.35	40.55
30		39.35	40.55
32	1.1/4"	39.35	40.55
35		47.25	48.50
38	1.1/2"	47.25	48.50
50	2"	58.90	60.60

Installation in fitting



- 1
- Lubricate O-Ring
 - ⚠ Steel fittings: No thread lubrication
 - Stainless steel fittings: Lubrication required
 - EO-NIROMONT is a special high-performance lubricant for stainless steel fittings

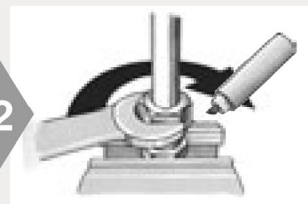

- 2
- Thread nut onto body
 - Tighten to full metal contact
 - Mark body and nut as quality check

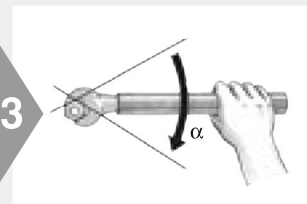

- 3
- Tighten to recommended torque level
 - Recommended: Tighten with spanner the number of flats indicated α
 - 1 flat = 60°

Tightening recommendation

Metric tube [mm]	Inch tube [inch]	SAE dash size	SAE thread	Assembly torque Nm -0% + 10%		α flats from wrench resistance method*	
				Steel	Stainless Steel	Tube	Swivel nut
6	1/4"	-4	9/16-18	25	32	1/4 - 1/2	1/2 - 3/4
8	5/16"	-6	1.1/16-16	40	50	1/4 - 1/2	1/2 - 3/4
10	3/8"	-6	1.1/16-16	40	50	1/4 - 1/2	1/2 - 3/4
12	1/2"	-8	1.3/16-16	65	70	1/4 - 1/2	1/2 - 3/4
14		-10	1-14	80	100	1/4 - 1/2	1/2 - 3/4
15		-10	1-14	80	100	1/4 - 1/2	1/2 - 3/4
16	5/8"	-10	1-14	80	100	1/4 - 1/2	1/2 - 3/4
18		-12	1.3/16-12	115	145	1/4 - 1/2	1/3 - 1/2
20	3/4"	-12	1.3/16-12	115	145	1/4 - 1/2	1/3 - 1/2
22		-16	1.7/16-12	150	190	1/4 - 1/2	1/3 - 1/2
25	1"	-16	1.7/16-12	150	190	1/4 - 1/2	1/3 - 1/2
28		-20	1.11/16-12	190	235	1/4 - 1/2	1/3 - 1/2
30		-20	1.11/16-12	190	235	1/4 - 1/2	1/3 - 1/2
32	1.1/4"	-20	1.11/16-12	190	235	1/4 - 1/2	1/3 - 1/2
35		-24	2-12	245	305	1/4 - 1/2	1/3 - 1/2
38	1.1/2"	-24	2-12	245	305	1/4 - 1/2	1/3 - 1/2
50	2"	-32	2.1/2-12	-	490	-	-

* "Flats From Wrench Resistance" Method for steel and stainless steel

O-Lok® Plus assembly instructions



O-Lok® Plus: Replacement of O-Ring

- Parker CORG assembly tool should be used for O-Lok® Plus fitting with captive O-ring groove (O-Lok® Plus)



1

- Insert the O-ring into the slot located on the side of the tool



2

- Position the open end of the tool over the tube-end of the fitting



3

- Push the piston of the tool until the O-ring is released into the fitting groove

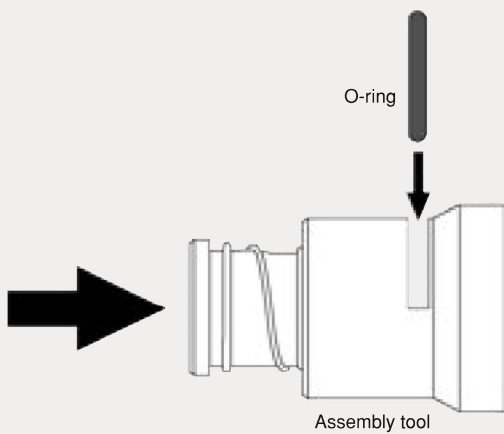

- Function of Parker CORG assembly tool

E

Triple-Lok® Plus assembly instructions



Tube selection

- Select suitable tube material

Steel tube		Stainless Steel tube
Cold drawn seamless	Welded & redrawn	Cold drawn seamless
NF A 49330	NF A 49341	
ISO 3304 R	DIN 2393	NF A 49341
DIN 2391C pt 1	BS 3602/2	DIN 17458 DA/T3
BS 3602 pt1	SAE J525	ASTM A 269
SAE J524		



Tube preparation

- Cut and deburr thoroughly

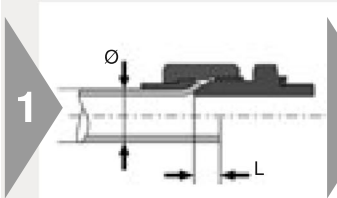

1

- Calculate tube length before cutting
- Add extra length "L"



2

- Minimum length L₁ of straight tube-ends (see chart below)



3

- Cut tube squarely
- max. ±1° deviation
- ⚠ Do not use pipe cutters
- Use tube cutting tool AV for manual cutting



4

- Remove internal and external burrs
- max. chamfer 0.3 mm × 45°
- Recommendation: In-Ex Tube Deburring Tool 226
- ⚠ Proper deburring and cleaning of inner diameter essential for sealing surface quality

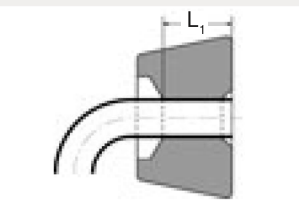

Tube preparation chart

Metric tube [mm]		Inch tube [inch]		Extra length - L [mm]	Minimum straight length to start to bend L ₁ [mm]
Tube Ø	Wall thickness	Tube Ø	Wall thickness		
6	1.0 - 1.5	1/4"	0.020 - 0.065	2	40
8	1.0 - 1.5	5/16"	0.020 - 0.065	2	40
10	1.0 - 1.5	3/8"	0.020 - 0.065	2	42
12	1.0 - 2.5	1/2"	0.028 - 0.083	2.5	43
14	1.5 - 2.0			2.5	52
15	1.0 - 2.5			2.5	52
16	1.5 - 2.5	5/8"	0.035 - 0.095	2.5	52
18	1.5 - 3.0			3	56
20	2.0 - 3.0	3/4"	0.035 - 0.109	3	57
22	1.5 - 3.0			3	58
25	2.0 - 3.0	1"	0.035 - 0.120	3	58
28	1.5 - 3.0			4	65
30	2.0 - 3.0			4	65
32	2.0 - 3.0	1.1/4"	0.049 - 0.120	4	65
35	2.0 - 3.0			4	70
38	2.0 - 4.0	1.1/2"	0.049 - 0.120	4	70
42*	2.0 - 3.0			5	80

- * Tube OD 42 mm:
- 1015: not suitable
- KarryFlare: special flaring pin KARRYFLARE/FPIN42 required

Triple-Lok® Plus assembly instructions

37° Flaring Parflange®-Process

- Preferred method
- Most efficient method
- Parflange® recommended

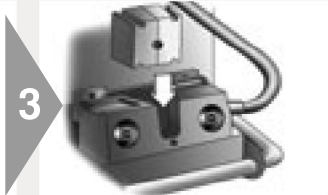

- Select flaring pin according to tube dimensions
- Use special "SS" pin for stainless steel tube
- Pin must be clean and free of wear and damage
- Load tooling into machine
- Keep flaring pin clean and lubricate regularly

- Select flaring dies according to tube dimensions
- Use special "SS" dies for stainless steel tube
- Grip surface must be clean and free of wear
- Use only genuine Parker tooling for flaring Triple-Lok® Plus

- Load tooling into machine
- Keep sliding surfaces clean and lubricated

- Slide nut and sleeve as shown onto the tube-end

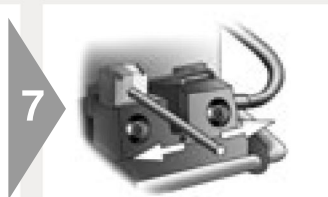
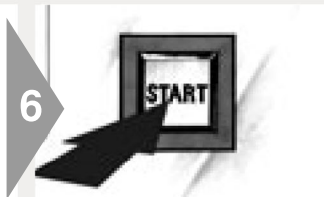
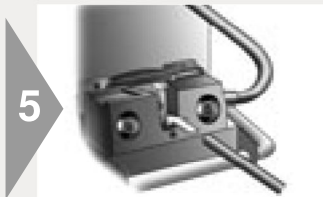

- ⚠ Press tube firmly into the die against the tube stop
- Parflange® 1025: Operate clamping lever
- Parflange® 1040: Automatic tube clamping

- Hold tube firmly
- Press start button
- ⚠ Keep hands clear off the working area

- Parflange® 1025: Unclamp the dies
- Parflange® 1040: Die unclamping is automatic
- Remove tube from machine
- Use die separator to free tube



Triple-Lok® Plus assembly instructions

37° Flaring with EOMAT/KarryFlare

- Preferred method
- Most efficient method
- Parflange® recommended



EOMAT II



EOMAT III/A



KarryFlare

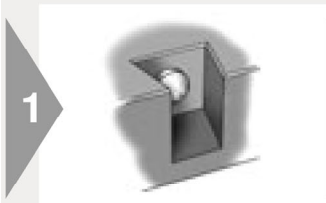

1

- Flaring pin is integrated in flaring block
- Pin must be clean and free of wear and damage
- Keep flaring pin clean
- KarryFlare: Flaring pin for 42 mm tube O.D. must be fitted with flat face on top



2

- Select flaring dies according to tube O.D.
- Grip surface must be clean and free of wear
- Use only genuine Parker tooling for flaring Triple-Lok® Plus
- Keep sliding surfaces clean and lubricated



3

- Slide nut and sleeve as shown onto the tube-end



4

- Lubricate tube-end inside
- Lubricant 1040SS recommended

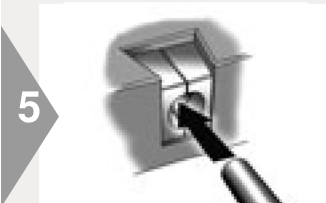

5

- ⚠ Press tube firmly into the die against the tube stop
- KarryFlare: Close valve on handpump
- KarryFlare: Keep lid closed



6

- EOMAT II: Adjustment according to pressure on machine
- EOMAT III/A: Menu selection (FLARE)
- KarryFlare: Refer to chart on machine
- Non-EOMAT-machines: check suitability



7

- Hold tube firmly
- EOMAT: Press and hold start button
- KarryFlare: Operate handpump until assembly pressure is reached
- ⚠ Keep hands clear off the working area
- ⚠ KarryFlare: Do not exceed max pressure 400 bar



8

- KarryFlare: Open valve on handpump
- Remove tube from machine
- Use die separator to free tube

Triple-Lok® Plus assembly instructions

Checking the flare



- Clean flare for inspection
 - ⚠ Check sealing surface for cracks, burrs, scratches and pitting

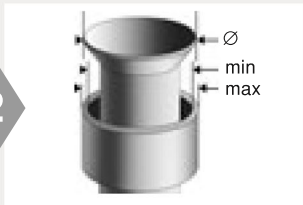

- Dimensional check of the flare
 - Flare O.D. should not exceed outside sleeve diameter
 - Flare O.D. should not be less than smaller diameter of front of sleeve
 - When in doubt, measure

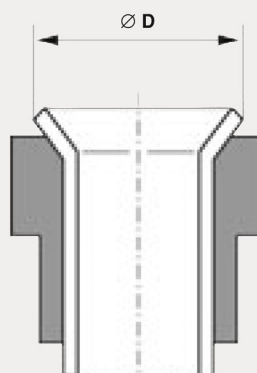

Tube O.D.		Ø D	
mm	inch	Min.	Max.
6	1/4"	8.6	9.7
8	5/16"	10.2	10.3
10	3/8"	11.7	12.7
12	1/2"	16.0	17.3
14		19.3	20.2
15		19.3	20.2
16	5/8"	19.3	20.2
18		23.4	24.7
20	3/4"	23.4	24.7
22	7/8"	26.5	27.8
25	1"	29.7	31.0
28		37.6	38.9
30		37.6	38.9
32	1.1/4"	37.6	38.9
35		43.2	45.3
38	1.1/2"	43.2	45.3
42		52.0	54.8

Installation



- Steel fittings: No lubrication
 - ⚠ Stainless steel fittings: Lubrication required
 - Use EO-NIROMONT special high-performance lubricant for stainless steel fittings

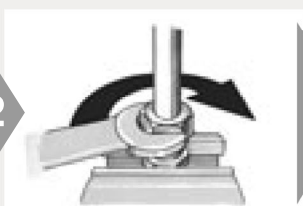

- Thread nut onto body
 - Tighten to full metal contact (finger tight)
 - Mark body and nut as quality check
 - Tighten with spanner the number of flats indicated

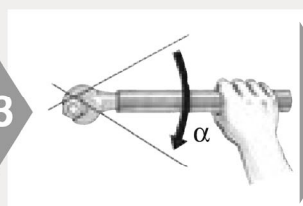

- Use spanner extension for larger fittings (28 mm)

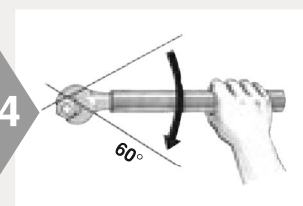

- 1 flat = 60°

Tightening recommendation

Metric tube [mm]	Inch tube [inch]	SAE thread	α flats from finger tight method*		Assembly torque Nm -0% + 10%	
			tube	Swivel nut	steel	stainless steel
6	1/4"	7/16-20	2"	2"	15	30
8	5/16"	1/2-20	2"	2"	20	40
10	3/8"	9/16-18	1.1/2"	1.1/4"	30	60
12	1/2"	3/4-16	1.1/2"	1"	60	115
14		7/8-14	1.1/2"	1"	75	145
15		7/8-14	1.1/2"	1"	75	145
16	5/8"	7/8-14	1.1/2"	1"	75	145
18		1.1/16-12	1.1/4"	1"	110	180
20	3/4"	1.1/16-12	1.1/4"	1"	110	180
22	7/8"	1.3/16-12	1"	1"	135	225
25	1"	1.5/16-12	1"	1"	175	255
28		1.5/8-12	1"		260	295
30		1.5/8-12	1"	1"	260	295
32	1.1/4"	1.5/8-12	1"	1"	260	295
35		1.7/8-12	1"		340	345
38	1.1/2"	1.7/8-12	1"	1"	340	345
42		2.1/4-12	1"	1"	380	400

* "Flats From Finger Tight" Method for steel and stainless steel

Checking instructions for O-Lok® Plus/Triple-Lok® Plus tools



Tools for Parflange® machines

- ⚠ Use of damaged, worn or non-suitable tooling may result in fitting failure and damage of machine
- ⚠ Tools must be checked regularly, at least after 50 assemblies
- ⚠ Worn tools must be replaced
- ⚠ Use only genuine Parker tools
- ⚠ Tools must always be kept clean and lubricated

1



- Clean pin for checking

2



- Visual check:
Surface must be free of wear and damage

3



- Clean die halves for checking
- ⚠ Do not disassemble
- Fixing pins must not be loose or damaged

4



- Visual check:
Grip surface must be clean and free of wear
- Use wire-brush to remove metal particles from grip surface



Adjustment of Parflange® dies

- Parflange® dies can be adjusted to correct deviations of flare diameter
- ⚠ Re-adjustment of dies will not help if general machine setting is incorrect or components are damaged (worn tube-stop, lose screw connections)

1



- To reduce the flare diameter, turn the screws anti-clockwise
- ⚠ Re-adjust both screws simultaneously

2



- To increase the flare diameter, turn the screws clockwise
- ⚠ Re-adjust both screws simultaneously

3

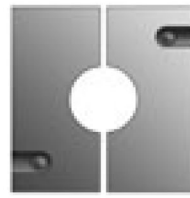

- Adjust the screws in small stages
- Then check flare diameter
- ⚠ Lock screws to prevent misadjustment

Flange-Seal assembly instructions



Tube selection

- Select suitable tube material

Steel tube

Cold drawn seamless	Welded & redrawn
NF A 49330	NF A 49341
ISO 3304 R	DIN 2393
DIN 2391C pt 1	BS 3602/2
BS 3602 pt1	SAE J525
SAE J524	



Tube preparation

- Cut and deburr thoroughly

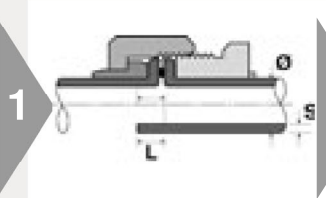

- Calculate tube length before cutting
- Add extra length "L" (see chart below)



- Minimum length of straight tube-ends (see chart below)

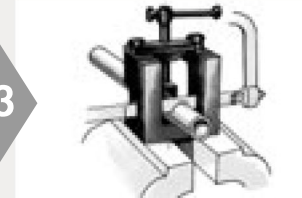

- Cut tube squarely
- max. $\pm 1^\circ$ deviation
- ⚠ Do not use pipe cutters
- Use tube-cutting tool AV for manual cutting



- Remove internal and external burrs
- max. chamfer $0.3 \text{ mm} \times 45^\circ$
- Recommendation: In-Ex Tube Deburring Tool 226
- ⚠ Proper deburring and cleaning of inner diameter essential for sealing surface quality

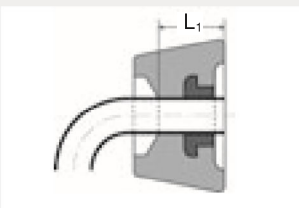

Tube \varnothing	Metric tube [mm] Wall thickness	Minimum straight length to start to bend L1 [mm]	Extra length – L [mm] for tube wall thickness								
			1	1.5	2	2.5	3	3.5	4		
6	1.0 - 1.5	50	4.5	5.5							
8	1.0 - 2.0	50	5.0	5.0							
10	1.0 - 2.0	50	2.5	4.0	3.5						
12	1.0 - 2.5	50	3.5	4.5	4.5	4.0					
16	1.5 - 3.0	50		3.0	3.0	3.0	2.5				
20	2.0 - 3.5	65		3.5	4.0	4.0	3.5				

Tube \varnothing	Inch tube [inch] Wall thickness	Minimum straight length to start to bend L1 [mm]	Extra length – L [mm] for tube wall thickness [inch]											
			0.028"	0.035"	0.049"	0.065"	0.083"	0.095"	0.109"	0.120"	0.134"	0.156"	0.188"	
1/4"	0.020 - 0.065	40	4.5	5.0	4.0									
3/8"	0.020 - 0.095	40		3.5	3.5	4.0	4.0	4.0						
1/2"	0.028 - 0.095	50		3.5	3.5	3.5	3.5	3.5						
5/8"	0.035 - 0.120	50			4.0	4.0	3.0	4.5	4.0	4.5				
3/4"	0.035 - 0.134	50			4.0	4.0	3.0	2.5	3.5	4.0	4.5			

Flange-Seal assembly instructions



Parflange® 1040



Parflange® 1025

Flange-Seal machine flanging and assembly

- Preferred method
- Most efficient method
- Parflange® recommended



1

- Parflange® machines:
- Select flaring pin according to tube dimensions
 - Use standard O-Lok® Plus pins
 - Pin must be clean and free of wear, damage and metal particles
 - Keep flaring pin clean and lubricate regularly

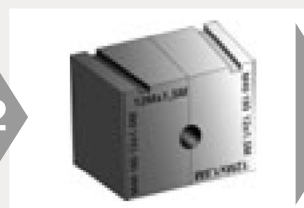

2

- Select flanging dies according to tube dimensions
 - Use special Flange-Seal dies
 - Grip surface must be clean and free of wear
 - Use only genuine Parker tooling for flanging
- ⚠ Note limitation on wall thickness for tube-tube connections



3

- Load pin into machine
- Ensure lubricating system is filled with oil (1040LUBSS)



4

- Place threaded sleeve (LHP) in lower die half
- Locate upper die half onto lower half



5

- Place the dies in the die housing



6

- ⚠ Press tube firmly into the die against the tube stop



7

- Pull down the handle to clamp the tube in the dies (1025)
 - 1040 die clamping automatic in cycle
 - Press button to start flanging cycle
- ⚠ Keep hands clear off the working area

Flange-Seal assembly instructions

8

- Parflange® 1025:
Unclamp the dies
- Remove tube from machine
- Use die separator to free tube
- Parflange® 1040:
Die unclamping is automatic

9

- Clean flange for inspection
- ⚠ Check sealing surface for cracks, burrs, scratches and pitting

10

- Dimensional check of the flare

Tube O.D.		Ø D	
mm	In.	min. [mm]	max. [mm]
6	1/4"	12.10	12.75
8		14.85	15.75
10	3/8"	14.85	15.75
12	1/2"	18.00	18.90
16	5/8"	22.20	23.45
20	3/4"	26.60	27.85

11

- Place seal into loose tube nut
- Tighten to full metal contact
- Tighten to recommended torque level

Tightening recommendation

Metric tube [mm]	Inch tube [inch]	SAE dash size	SAE thread	Assembly torque Nm -0% + 10% Steel
6	1/4"	-4	9/16-18	25
8	5/16"	-6	1.1/16-16	40
10	3/8"	-6	1.1/16-16	40
12	1/2"	-8	1.3/16-16	65
16	5/8"	-10	1-14	80
20	3/4"	-12	1.3/16-12	115

System component guide - Flange-Seal system - Metric tubes

Tube O.D. (mm)	Con. dash size	Flange-Seal fitting	Seal element	Die tool*	Pin tool
6	4	LHMPS6	4PLS	M4018006XxxxMLHP	B3018006XxxxM
8	6	LHMPS8	6PLS	M4018008XxxxMLHP	B3018008XxxxM
10	6	LHMPS10	6PLS	M4018010XxxxMLHP	B3018010XxxxM
12	8	LHMPS12	8PLS	M4018012XxxxMLHP	B3018012XxxxM
16	10	LHMPS16	10PLS	M4018016XxxxMLHP	B3018016XxxxM
20	12	LHMPS20	12PLS	M4018020XxxxMLHP	B3018020XxxxM

*xxx: Insert tube wall thickness according to tooling list
 *Example 1: Metric tube tooling for 8x1.5 mm
 Die: M4018008x1.5MLHP
 Pin: B3018008x1.5M

System component guide - Flange-Seal system - Inch tubes

Tube O.D. (inch)	Con. dash size	Flange-Seal fitting	Seal element	Die tool*	Pin tool
1/4"	4	4LHP-S	4PLS	M4004Xxxx180LHP	B4004Xxxx180
3/8"	6	6LHP-S	6PLS	M4006Xxxx180LHP	B4006Xxxx180
1/2"	8	8LHP-S	8PLS	M4008Xxxx180LHP	B4008Xxxx180
5/8"	10	10LHP-S	10PLS	M4010Xxxx180LHP	B4010Xxxx180
3/4"	12	12LHP-S	12PLS	M4012Xxxx180LHP	B4012Xxxx180

*xxx: Insert tube wall thickness according to tooling list
 *Example 2: Inch tube tooling for 1/2x0.083"
 Die: M4008x083180LHP
 Pin: B4008x083180